



# Board of Adjustment Staff Report

Meeting Date: August 3, 2023

Agenda Item: 9C

SPECIAL USE PERMIT CASE NUMBER:	WSUP22-0019 (Safe Embrace)
BRIEF SUMMARY OF REQUEST:	To allow a Group Care Facility
STAFF PLANNER:	Julee Olander, Planner Phone Number: 775.328.3627 E-mail: jolander@washoecounty.gov

### CASE DESCRIPTION

For hearing, discussion, and possible action to approve a special use permit to allow a group care facility for up to 25 occupants if connected to city sewer, or up to 18 occupants if utilizing the existing septic system. The regulatory zone of the parcel is Low Density Suburban (LDS) and a special use permit is required per Washoe County Code Table 110.302.05.2. The proposal also requests to modify the parking requirements in Washoe County Development Code Article 410 by not requiring any additional paved parking spaces or additional lighting in the parking area.

Applicant/ Property Owner	Safe Embrace
Location:	1995 Ponderosa Drive
APN:	026-422-14
Parcel Size:	1 acre
Master Plan:	Suburban Residential (SR)
Regulatory Zone:	Low Density Suburban (LDS)
Development Code:	Authorized in Article 304, Allowed Use, 322 Group Care Facilities & Article 810, Special Use Permits
Commission District:	3 – Commissioner Garica

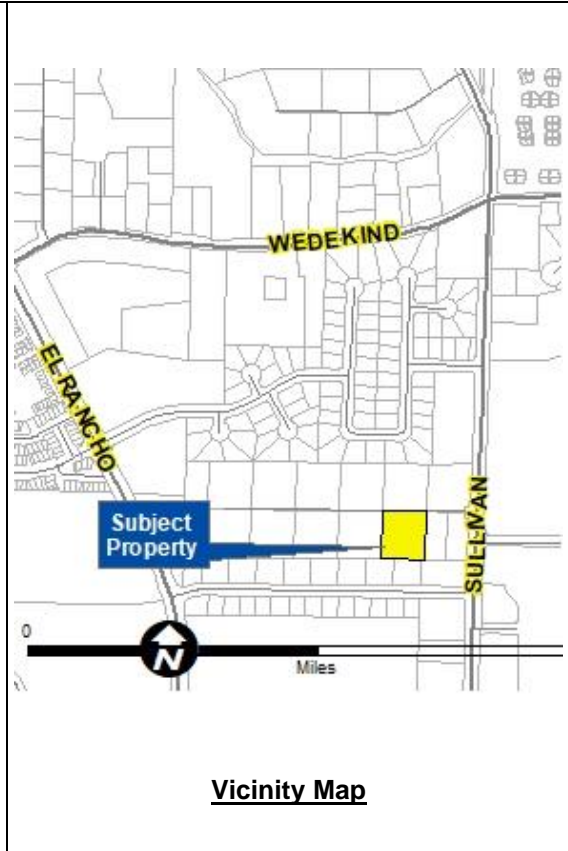

### STAFF RECOMMENDATION

APPROVE

**APPROVE WITH CONDITIONS**

DENY

### POSSIBLE MOTION

I move that, after giving reasoned consideration to the information contained in the staff report and information received during the public hearing, the Washoe County Board of Adjustment approve with conditions Special Use Permit Case Number WSUP22-0019 for Safe Embrace, to include varying the requested lighting and parking/paving requirements, with the conditions included as Exhibit A to this matter, having made all five findings in accordance with Washoe County Code Section 110.810.30

*(Motion with Findings on Page 9)*

**Staff Report Contents**

Special Use Permit ..... 3

Site Plan..... 4

Background..... 4

Project Evaluation ..... 5

Site Characteristics ..... 6

Landscaping..... 6

Utilities and Services..... 6

Modifications ..... 6

Neighborhood Meeting..... 8

Area Plan Evaluation ..... 8

Reviewing Agencies..... 8

Recommendation ..... 9

Motion ..... 10

Appeal Process..... 10

---

**Exhibits Contents**

Conditions of Approval..... Exhibit A

Agency Comments..... Exhibit B

Neighborhood Meeting Summary ..... Exhibit C

\* Public Comments ..... Exhibit D

Public Notice ..... Exhibit E

Project Application ..... Exhibit F

\* The exhibits submitted with the Public Comments (Exhibit D) are extensive. To review the complete exhibit click [here](#) or go to:

[https://www.washoecounty.gov/csd/planning\\_and\\_development/board\\_commission/board\\_of\\_adjustment/2023/files/ExhibitD\\_PublicComment\\_exhibit1-20.pdf](https://www.washoecounty.gov/csd/planning_and_development/board_commission/board_of_adjustment/2023/files/ExhibitD_PublicComment_exhibit1-20.pdf)

or contact Adriana Albarran at [aalbarran@washoecounty.gov](mailto:aalbarran@washoecounty.gov) to have a copy sent by email.

**Special Use Permit**

The purpose of a special use permit is to allow a method of review to identify any potential harmful impacts on adjacent properties or surrounding areas for uses that may be appropriate within a regulatory zone; and to provide for a procedure whereby such uses might be permitted by further restricting or conditioning them so as to mitigate or eliminate possible adverse impacts. If the Board of Adjustment grants an approval of the special use permit, that approval is subject to conditions of approval. Conditions of approval are requirements that need to be completed during different stages of the proposed project. Those stages are typically:

- Prior to permit issuance (i.e. a grading permit, a building permit, etc.)
- Prior to obtaining a final inspection and/or a certificate of occupancy on a structure
- Prior to the issuance of a business license or other permits/licenses
- Some conditions of approval are referred to as “operational conditions.” These conditions must be continually complied with for the life of the business or project.

The conditions of approval for Special Use Permit Case Number WSUP22-0019 are attached to this staff report and will be included with the action order.

The subject property is designated as Low Density Suburban (LDS). The proposed use of group care facility is classified as a civic use and is permitted in LDS with a special use permit per WCC Table 110.302.05.2. Therefore, the applicant is seeking approval of this SUP from the Board of Adjustment.

Additionally, Article 810, Special Use Permits, allows the Board of Adjustment to vary development code standards in conjunction with the approval process per WCC 110.810.20(e). The Board of Adjustment will be ruling on the request(s) to vary standards below:

Variance(s) Requested	Relevant Code
Paved parking spaces	110.410.25(e)
Lighting	110.410.25(g)



**Site Plan**

### **Background**

Safe Embrace is an organization that provides counseling, housing and shelter services for victims of domestic and sexual abuse and human trafficking. Safe Embrace has been located at this site for over 20 years. Other organizations and shelters have been on the site since 1994. The site is currently being used as a group home, with 10 occupants or less.

The site was located within the City of Sparks sphere-of-influence (SOI), however it was removed from the SOI and brought back into Washoe County's jurisdiction in 2020. While the site was in the City of Sparks SOI, planning applications were submitted, reviewed and approved by the Sparks Planning Department. Business licenses and building permits were submitted to Washoe County and reviewed by other departments and agencies, including the City of Sparks. With the change of jurisdiction, all planning, business license, and building applications are now submitted to Washoe County for review and approval.

The SUP application (WSUP22-0019) was originally submitted on August 8, 2022. However, during the review process there were concerns regarding whether the existing septic system could

adequately serve the proposed group care facility. The applicant requested to put the application on hold until the septic system questions could be resolved with the Washoe County District Health Department. The research by the applicant found that the septic field is sized for an 18-bed facility after the upgrades in 2018. The applicant has provided documentation for the Onsite Sewage Disposal System (OSDS) application and approval letter from the Nevada Division of Environmental Protection (NDEP) as part of their application (See Exhibit F, pages 18-22). The applicant is currently discussing with the City of Sparks the possibility of connecting with City of Sparks sewer system.

**Project Evaluation**

The applicant is seeking approval for a special use permit (SUP) to allow a group care facility to serve up to 25 occupants if connected to city sewer or 18 occupants if utilizing the existing septic system. The regulatory zone of the parcel is Low Density Suburban (LDS) and a special use permit is required per Washoe County Code Table (WCC) 110.302.05.2. The applicant has also stated that the facility is in compliance with Article 322, Group Care Facilities requirements.

The facility provides care for temporary residents, to include women, men and children, with the length of stay limited to 90 days per occupant. There are typically 4 staff members on site. The facility is “willing to hire an additional advocate to reside at the site during the overnight hours” to address neighbors’ concerns. The application also proposes, “upgrading the cameras and security system to allow for monitoring of the exterior of the residence” along with “the development code guidelines, Safe Embrace is preparing a Neighborhood Response Program”, which are intended to further help address neighbors’ concerns. According to the application this program “will include contact numbers and emails for the Executive Director and Shelter Manager in addition to a scheduled weekly in-person check in with neighborhood residents to discuss neighborhood problems, suggestions and improvements to the group care facility”.

Per WWC 110.322.10(c) “a minimum of twelve hundred (1,200) square feet of interior space shall be provided for the first six (6) facility users, and one hundred fifty (150) square feet of interior space for each additional facility user”. If the facility has 25 occupants the required interior space is 4,050 SF and the building currently has 5,706 SF of interior space. The facility has a total of 8 bedrooms with the following square footage and living space:

<b>Building</b>	<b>Interior Space SF</b>	<b>Living Space SF</b>	<b>Bedrooms</b>
Main House	2,131	1,706	4 bedrooms
Garage Conversion	650	650	0
New Addition	1,925	700	4 bedrooms
Office/Misc.	1,000	1,000	0
<b>Total</b>	<b>5,706</b>	<b>4,056</b>	<b>8 bedrooms</b>

Per WCC 110.322.10(d), “A minimum of six hundred (600) square feet of outdoor recreation area shall be provided for the first six (6) facility users, and seventy-five (75) square feet of outdoor recreation area for each additional facility user”. If the facility has 25 facility users it is required to have 2,025 SF of outdoor recreational area. The application indicates there is 3,300 SF outdoor recreational area at the rear of the property for the residents’ use.

A pet shelter will be available to house 3 dogs and 6 cats or small animals. The dog runs (see the site plan on page 4) includes an indoor and outdoor area. There have been previous



complaints of dogs barking. The applicant indicates that new pet policies have been put in place to address barking dogs and other pet nuisances and dogs will not be allowed in the outside runs at night.



### **Site Characteristics**

The building is a single story building. The attached garage was converted into living space in 2007. The buildings meet LDS setback except for a detached garage that was converted into work and office space in 2006 (See Site Plan on page 4).

The parcel and the surrounding parcels to the west, east and north are master planned Suburban Residential (SR) and have a regulatory zone of Low Density Suburban (LDS). The parcels to the south are in the City of Sparks, with single family zoning.

### **Landscaping**

There is landscaping on the site and the applicant is proposing to meet Washoe County code requirement of 20% of the site being landscaped as required for commercial use. Additionally, the applicant is proposing to add one tree for every 50 linear feet of street frontage with additional bushes between the trees.

### **Utilities and Services**

The site is currently connected to septic that can serve an 18-occupant facility according to an approval letter from NDEP (See Exhibit E, pages 18-22). The applicant is in discussion with the City of Sparks to connect to sewer service. If the site is connected to sewer the applicant is requesting to increase the facility to allow 25-occupants.

The closest fire station and emergency service is the City of Sparks fire station on Victorian Avenue, which is 1.5 miles from the site. The facility also is ADA compliant and has fire sprinklers throughout the buildings. Washoe County Sheriff will provide policing services.

### **Modifications**

#### **Parking**

The applicant is requesting to vary the parking requirements by not requiring the existing unpaved parking spaces to be paved. The facility is considered a commercial use and WCC 110.410.25(e) requires "All parking spaces, driveways and maneuvering areas shall be paved and permanently maintained with asphalt or cement." The applicant is requesting to vary this requirement to maintain the neighborhood character of the site and to preserve the similar look of the neighboring properties. There are neighboring properties that have unpaved parking areas and driveways and the neighbors have expressed that they want to maintain a residential look to the facility.

The existing parking is located in a gravel area along the north end of the western property boundary and along the paved circular drive. There are 10 unpaved parking spaces (4 for employees and 6 for residents/visitors) in this area (see photographs below & site plan on page 4). Per WWC Table 110.410.10.2 group care requires 1 parking space per employee during peak employment shift and one parking space per .25 beds. The facility proposes 25 beds (occupants) and requires 6 spaces and the applicant indicates that 4 spaces will meet the employee requirement.

Lighting

The applicant is requesting to vary all lighting requirements per WCC 110.410.25(g), which requires lighting in parking lots areas. The applicant is again requesting to vary this requirement to maintain the neighborhood character of the site and to have preserve the similar look of the neighboring properties. The property is not open to the public and the applicant is requesting that no more lighting be required. There is a porch light and lighting on the rear of the house.

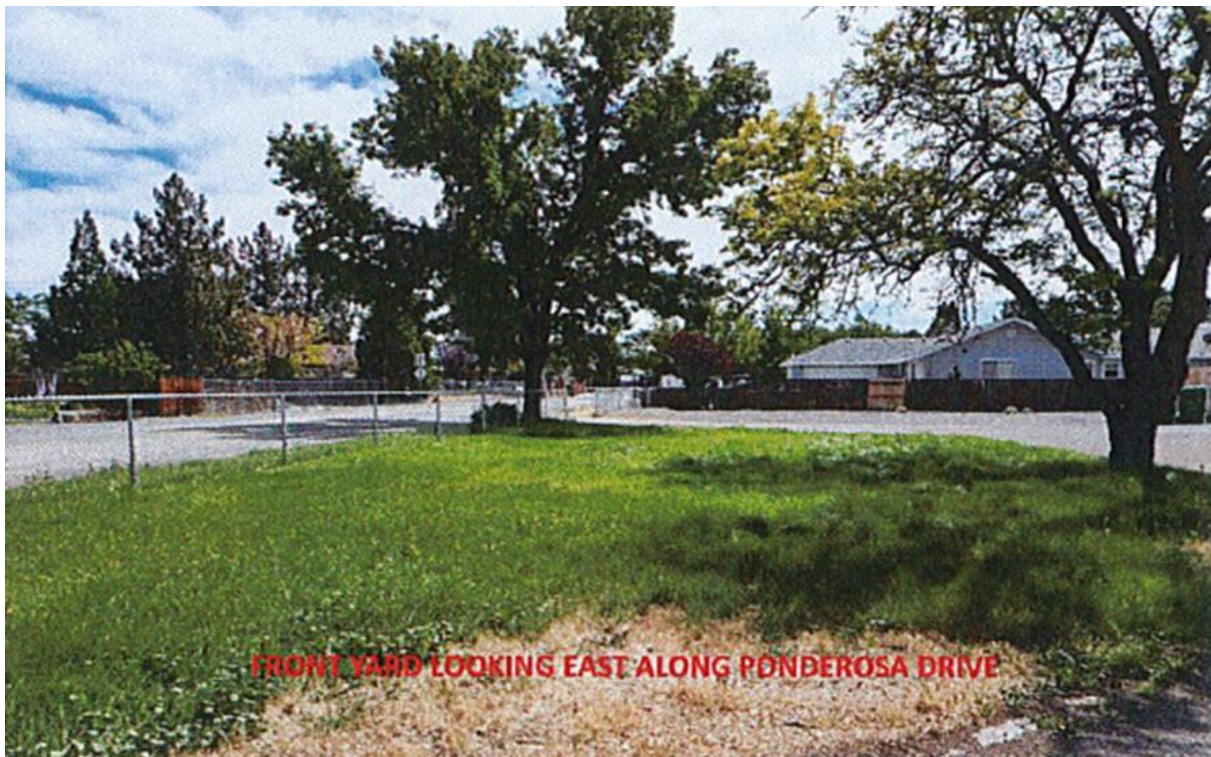
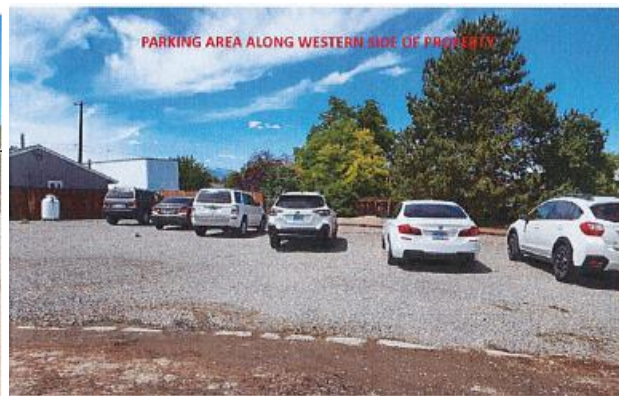



### **Neighborhood Meeting**

The applicant held a two neighborhood meeting one July 18, 2022 and a follow-up meeting on May 23, 2023 by Zoom. The attendees overall were not in opposition of Safe Embrace but felt it should be located elsewhere. The comments for the attendees included:

- Safety and security of the neighborhood
- Enforcement of any SUP conditions
- Noise from dogs and residents
- Traffic
- Road maintenance on the private road

### **Area Plan Evaluation**

The subject parcel is located within the Northeast Truckee Meadows Planning Area. However, the property is located outside of any of the 13 active area plans of the Washoe County Master Plan.

### **Reviewing Agencies**

The following agencies/individuals received a copy of the project application for review and evaluation.

<b>Agencies</b>	<b>Sent to Review</b>	<b>Responded</b>	<b>Provided Conditions</b>	<b>Contact</b>
Washoe County Building & Safety	X			
Washoe County Engineering & Capital Projects	X	X	X	Robert Wimer, <a href="mailto:rwimer@washoecounty.gov">rwimer@washoecounty.gov</a>
Washoe County Sewer	X			
Washoe County Traffic	X			
Washoe County Water Rights Manager	X			
WCHD EMS	X	X		Sabrina Brasuell, <a href="mailto:sbrasuell@washoecounty.gov">sbrasuell@washoecounty.gov</a>
WCHD Environmental Health	X	X	X	Jim English, <a href="mailto:jenglish@washoecounty.gov">jenglish@washoecounty.gov</a> ;
Sparks Fire	X			
TMFPD	X	X		Brittany Lemon Blemon <a href="mailto:blemon@tmfpd@us">blemon@tmfpd@us</a>
Sparks Community Services Dept.	X			
AT&T	X	X		Bryson Gordon, <a href="mailto:bg1853@att.com">bg1853@att.com</a>
NV Energy	X			
Truckee Meadows Water Authority	X			

All conditions required by the contacted agencies can be found in Exhibit A, Conditions of Approval.

### **Staff Comment on Required Findings**

WCC Section 110.810.30, Article 810, *Special Use Permits*, requires that all of the following findings be made to the satisfaction of the Washoe County Board of Adjustment before granting approval of the request. Staff has completed an analysis of the special use permit application and has determined that the proposal is in compliance with the required findings as follows.



- (a) Consistency. That the proposed use is consistent with the action programs, policies, standards and maps of the Master Plan.

*Staff Comment: The property is not located within one of the 13 active area plans of the Washoe County Master Plan. The Master Plan elements have no action programs, policies, standards or maps prohibiting the establishment of a group care facility. The facility has been in existence for the past 20 years.*

- (b) Improvements. That adequate utilities, roadway improvements, sanitation, water supply, drainage, and other necessary facilities have been provided, the proposed improvements are properly related to existing and proposed roadways, and an adequate public facilities determination has been made in accordance with Division Seven.

*Staff Comment: The group care facility is an existing facility and is already connected to the existing services, including water service and power on the site. The site has a septic system that will support an 18-bed facility and if the site is connected to sewer, it will support a 25-bed facility.*

- (c) Site Suitability. That the site is physically suitable for group care facility and for the intensity of such a development.

*Staff Comment: A group care facility has been located on the site for over 20 years. The special use permit will enable the facility to meet all Washoe County codes. The group care facility meets the setbacks for the LDS regulatory zone, except for a garage that was converted into work/office space in 2006.*

- (d) Issuance Not Detrimental. That issuance of the permit will not be significantly detrimental to the public health, safety or welfare; injurious to the property or improvements of adjacent properties; or detrimental to the character of the surrounding area.

*Staff Comment: A group care facility has been located on the site for over 20 years. The special use permit is required per Washoe County code and will confirm that the facility meets Washoe County Code. Residential homes are adjacent to the site and the applicant has provide numerous responses to address the neighbor concerns, including onsite staff 24 hours a day, an upgrade the security system, and a Neighborhood Response Program. The applicant indicates that the facility will continue to address negative impacts as they occur and will seek to mitigate issues.*

5. Effect on a Military Installation. Issuance of the permit will not have a detrimental effect on the location, purpose or mission of the military installation.

*Staff Comment: There are no military installations in the area. Therefore, there is no detrimental effect.*

### **Recommendation**

After a thorough analysis and review, Special Use Permit Case Number WSUP22-0019 is being recommended for approval with conditions. Staff offers the following motion for the Board's consideration.

**Motion**

I move that, after giving reasoned consideration to the information contained in the staff report and information received during the public hearing, the Washoe County Board of Adjustment approve with conditions Special Use Permit Case Number WSUP22-0019 for Safe Embrace to include varying the requested lighting and parking/paving requirements, with the conditions included as Exhibit A to this matter, having made all five findings in accordance with Washoe County Code Section 110.810.30:

- (a) Consistency. That the proposed use is consistent with the action programs, policies, standards and maps of the Master Plan and the Northeast Area Plan;
- (b) Improvements. That adequate utilities, roadway improvements, sanitation, water supply, drainage, and other necessary facilities have been provided, the proposed improvements are properly related to existing and proposed roadways, and an adequate public facilities determination has been made in accordance with Division Seven;
- (c) Site Suitability. That the site is physically suitable for a group care facility and for the intensity of such a development;
- (d) Issuance Not Detrimental. That issuance of the permit will not be significantly detrimental to the public health, safety or welfare; injurious to the property or improvements of adjacent properties; or detrimental to the character of the surrounding area;
- (e) Effect on a Military Installation. Issuance of the permit will not have a detrimental effect on the location, purpose or mission of the military installation.

**Appeal Process**

Board of Adjustment action will be effective 10 calendar days after the written decision is filed with the Secretary to the Board of Adjustment and mailed to the applicant, unless the action is appealed to the Washoe County Board of County Commissioners, in which case the outcome of the appeal shall be determined by the Washoe County Board of County Commissioners. Any appeal must be filed in writing with the Planning and Building Division within 10 calendar days from the date the written decision is filed with the Secretary to the Board of Adjustment and mailed to the applicant.

Applicant/Owner: Safe Embrace., Attn: Afshan West  
[afshan@safeembrace.org](mailto:afshan@safeembrace.org)

Representatives: Christy Corporation., Attn: Lisa Nash  
[Lisa@christynv.com](mailto:Lisa@christynv.com)



# Conditions of Approval

Special Use Permit Case Number WSUP22-0019

The project approved under Special Use Permit Case Number WSUP22-0019 shall be carried out in accordance with the conditions of approval granted by the Board of Adjustment on August 3, 2023. Conditions of approval are requirements placed on a permit or development by each reviewing agency. These conditions of approval may require submittal of documents, applications, fees, inspections, amendments to plans, and more. These conditions do not relieve the applicant of the obligation to obtain any other approvals and licenses from relevant authorities required under any other act.

**Unless otherwise specified**, all conditions related to the approval of this special use permit shall be met or financial assurance must be provided to satisfy the conditions of approval prior to issuance of a grading or building permit. The agency responsible for determining compliance with a specific condition shall determine whether the condition must be fully completed or whether the applicant shall be offered the option of providing financial assurance. All agreements, easements, or other documentation required by these conditions shall have a copy filed with the County Engineer and the Planning and Building Division.

Compliance with the conditions of approval related to this special use permit is the responsibility of the applicant, his/her successor in interest, and all owners, assignees, and occupants of the property and their successors in interest. Failure to comply with any of the conditions imposed in the approval of the special use permit may result in the institution of revocation procedures.

Washoe County reserves the right to review and revise the conditions of approval related to this Special Use Permit should it be determined that a subsequent license or permit issued by Washoe County violates the intent of this approval.

For the purpose of conditions imposed by Washoe County, “may” is permissive and “shall” or “must” is mandatory.

Conditions of approval are usually complied with at different stages of the proposed project. Those stages are typically:

- Prior to permit issuance (i.e., grading permits, building permits, etc.).
- Prior to obtaining a final inspection and/or a certificate of occupancy.
- Prior to the issuance of a business license or other permits/licenses.
- Some “conditions of approval” are referred to as “operational conditions.” These conditions must be continually complied with for the life of the project or business.

**The Washoe County Commission oversees many of the reviewing agencies/departments with the exception of the following agencies.**

- **The DISTRICT BOARD OF HEALTH, through the Washoe County Health District, has jurisdiction over all public health matters in the Health District. Any conditions set by the Health District must be appealed to the District Board of Health.**

FOLLOWING ARE CONDITIONS OF APPROVAL REQUIRED BY THE REVIEWING AGENCIES. EACH CONDITION MUST BE MET TO THE SATISFACTION OF THE ISSUING AGENCY.

**Washoe County Planning and Building Division**

1. The following conditions are requirements of Planning and Building, which shall be responsible for determining compliance with these conditions.

**Contact Name – Julee Olander, Planner, 775.328.3627, [jolander@washoecounty.gov](mailto:jolander@washoecounty.gov)**

- a. **The applicant shall attach a copy of the action order approving this project to all permits and applications (including building permits) applied for as part of this special use permit.**
- b. The site will meeting commercial use landscaping requirements per Article 412.
- c. The business license will be obtained to for the new use.
- d. The following **Operational Conditions** shall be required for the life of the business:
  - i. This special use permit shall remain in effect until or unless it is revoked or is inactive for one year.
  - ii. Failure to comply with any of the conditions of approval shall render this approval out of conformance and subject to revocation.
  - iii. The applicant and any successors shall direct any potential purchaser/operator of the site and/or the administrative permit to meet with Planning and Building to review conditions of approval prior to the final sale of the site and/or the administrative permit. Any subsequent purchaser/operator of the site and/or the administrative permit shall notify Planning and Building of the name, address, telephone number, and contact person of the new purchaser/operator within 30 days of the final sale.
  - iv. This special use permit shall remain in effect as long as the business is in operation and maintains a valid business license.

**Washoe County Engineering and Capital Projects**

2. The following conditions are requirements of the Engineering Division, which shall be responsible for determining compliance with these conditions.

**Contact Name – Mitchell Fink, P.E. 775.328.2050, [mfink@washoecounty.gov](mailto:mfink@washoecounty.gov)**

- a. The Regional Road Impact Fee (RRIF) may be applied with the building permit at the nursing home rate, due to a change in the original land use from a single-family residence. Unless it can be shown that previous RRIF fees were paid under the nursing home land-use classification.

**Truckee Meadows Fire Protection District**

3. The following condition is a requirement of the Truckee Meadows Fire Protection District, which shall be responsible for determining compliance with this condition.

**Contact Name – Brittany Lemon, Fire Captain 775.326.6079, [blemon@tmfpd.us](mailto:blemon@tmfpd.us)**

- a. This project shall meet and comply with all requirements of currently adopted TMFPD fire codes, ordinances, and standards at the time of construction to include infrastructure for fire apparatus access roads and water supply. <https://tmfpd.us/fire-code/>

**Washoe County Water Management Planner Coordinator**

4. The following conditions are requirements of Washoe County Water Management Planner Coordinator, who shall be responsible for determining compliance with these conditions.

**Contact: Timber Weiss, 775.328.3699, [tweiss@washoecounty.gov](mailto:tweiss@washoecounty.gov)**



- a. This parcel is within TMWA service area and currently receives municipal water service from TMWA. The applicant shall conform with the requirements of TMWA in regard to water rights and water service. TMWA requires that all water service conditions to be met prior to approval of building permits. Recommend approval of this permit, with written approval or will-serve from TMWA to provide service for the additional use on this property prior to building permit issuance. Please upload TMWA will-serve notice or acknowledgement as a document to the building permit for this project or email the written acknowledgement to [tweiss@washoecounty.gov](mailto:tweiss@washoecounty.gov).

**Washoe County Health District**

5. The following conditions are requirements of Environment Health Services, which shall be responsible for determining compliance with these conditions.

**Contact Name – James English, 775.328.2610, [jenglish@washoecounty.gov](mailto:jenglish@washoecounty.gov)**

- a. The WCHD has reviewed the above referenced application and recommends the special use permit be approved with a connection to public sewer.
- b. For WCHD to support or recommend approval of the special use permit for an 18 bed system served by an onsite sewage disposal system, the applicant must get in writing from Washoe County Planning Division and the applicable fire agency if the onsite sewage disposal system fails, the current driveway and potential parking spaces may be removed and not replaced for the installation of the repair field per the approved plans and permit requirements.

\*\*\* End of Conditions \*\*\*

**From:** [GORDON, BRYSON](#)  
**To:** [Olander, Julie](#)  
**Cc:** [COOPER, CLIFFORD E](#)  
**Subject:** June Agency Review Memo 1  
**Date:** Thursday, June 15, 2023 9:16:20 AM

---

[**NOTICE:** This message originated outside of Washoe County -- **DO NOT CLICK** on **links** or open **attachments** unless you are sure the content is safe.]

Hello Julie,  
AT&T has no adverse comments or concerns regarding -

**Special Use Permit Case Number WSUP22-0019 (Safe Embrace)**

Thank you,

Bryson Gordon  
MGR OSP PLNG & ENGRG DESIGN  
AT&T NEVADA ROW  
1375 Capital Blvd. rm115. Reno, NV 89502  
Cell: 775-343-6655  
E-mail: [bg1853@att.com](mailto:bg1853@att.com)

**From:** [Program, EMS](#)  
**To:** [Olander, Julee](#)  
**Cc:** [Program, EMS](#)  
**Subject:** FW: June Agency Review Memo I - Special Use Permit Case Number WSUP22-0019 (Safe Embrace)  
**Date:** Tuesday, June 20, 2023 1:06:15 PM

---

Hi Julee,

The EMS Program has reviewed the June Agency Review Memo I - Special Use Permit Case Number WSUP22-0019 (Safe Embrace)- and had only one comment.

The permit references "TMFPD" as the first station services for this location.

10. Community Services (provided and nearest facility):

a. Fire Station	TMFPD
b. Health Care Facility	Renown
c. Elementary School	Risley
d. Middle School	Sparks Middle School
e. High School	Hug High School
f. Parks	Washoe County Parks
g. Library	Sparks Library
h. Citifare Bus Stop	Greenbrae and Sullivan

Based on WCHD GIS maps, TMFPD is not the closest. The closest is SFD on Victorian at 1.5 miles, followed by RFD on Sutro at 2.4 miles. TMFPD closest station is 4.2 miles away at Sun Valley.

The Program sees no additional concerns/has no additional comments.

Thank you,

Sabrina.

**Sabrina Brasuell**

Pronouns: she/her

Office hours: 7:00AM – 3:30PM Remote on Mondays

EMS Coordinator | Epidemiology and Public Health Preparedness

Washoe County Health District

[sbrasuell@washoecounty.gov](mailto:sbrasuell@washoecounty.gov) | Cell: (775) 830-7118 | Office: (775) 326-6043

1001 E. Ninth St., Bldg. B. Reno, NV 89512



Please take our customer satisfaction survey by clicking [here](#)





Date: June 27, 2023

To: Julee Olander, Planner

From: Robert Wimer, P.E., Licensed Engineer

Re: Special Use Permit for **Safe Embrace WSUP22-0019**  
APN 026-422-14

## GENERAL PROJECT DISCUSSION

Washoe County Engineering staff has reviewed the above referenced application. The Special Use Permit is for the establishment of a 25-bed group care facility and is located on approximately 1.0 acres at the south side of Ponderosa Drive, west of the intersection with Sullivan Lane. The Engineering and Capital Projects Division recommends approval with the following comments and conditions of approval which supplement applicable County Code and are based upon our review of the site and the application prepared by Christy Corporation, LTD. The County Engineer shall determine compliance with the following conditions of approval.

For questions related to sections below, please see the contact's name provided.

## GENERAL CONDITIONS

Contact Information: Robert Wimer, P.E. (775) 328-2059

**Discussion:** It appears that the indoor space of the existing home and converted garage equals 3,780 square feet on the Assessor's Parcel Information. As stated in the application, the required indoor space for 25 beds is 4,050 square feet. Therefore, there does not appear to be sufficient indoor space to accommodate the request for 25 beds. **This information was updated by Julee Olander on 6-27-2023, and staff no longer has any concerns regarding this requirement.**

## DRAINAGE (COUNTY CODE 110.416, 110.420, and 110.421)

Contact Information: Robert Wimer, P.E. (775) 328-2059

No drainage comments.

## TRAFFIC AND ROADWAY (COUNTY CODE 110.436)

Contact Information: Mitch Fink, (775) 328-2050

1. The Regional Road Impact Fee (RRIF) may be applied with the building permit at the nursing home rate, due to a change in the original land use from a single-family

**WSUP22-0019**

**EXHIBIT B**

residence. Unless it can be shown that previous RRIF fees were paid under the nursing home land-use classification.

**UTILITIES (County Code 422 & Sewer Ordinance)**

Contact Information: Alex Mayorga, P.E. (775) 328-2313

1. Connection to City of Sparks sewer system shall be completed if there are more than 18-beds in the establishment of the Group Care Facility. If there are more than 18 beds., a will-serve and receipt of payment for sewer connection from the City of Sparks shall be obtained prior to any building permit being issued
2. The proper sewer and access easements for connection to the City of Sparks sanitary sewer collection system shall be obtained and recorded prior to issuance of a building permit. The recorded sewer and access easement documents shall clearly show who is the owner of the sewer facilities and who is responsible for maintenance and shall be signed by the responsible party.

**WSUP22-0019**  
**EXHIBIT B**

**From:** [Lemon, Brittany](#)  
**To:** [Olander, Julee](#)  
**Cc:** [Way, Dale](#)  
**Subject:** WSUP22-0019 (Safe Embrace) Conditions of Approval  
**Date:** Thursday, June 15, 2023 11:22:11 AM  
**Attachments:** [image001.png](#)

---

Hi Julee,

TMFPD has no comments on this request, as the building is already in existence and is provided with proper fire protection.

Thank you,

**Brittany Lemon**

**Fire Captain - Fire Prevention | Truckee Meadows Fire & Rescue**

[blemon@tmfpd.us](mailto:blemon@tmfpd.us) | Office: 775.326.6079 | Cell: 775.379.0584

3663 Barron Way, Reno, NV 89511



*"Committed to excellence, service, and the protection of life and property in our community"*

WASHOE COUNTY  
**HEALTH DISTRICT**  
ENHANCING QUALITY OF LIFE

June 26, 2023

Washoe County Community Services  
Planning and Development Division

RE: Safe Embrace; 026-422-14  
Special Use Permit; WSUP22-0019

Dear Washoe County Staff:

The following conditions are requirements of the Washoe County Health District, Environmental Health Services Division, (WCHD), which shall be responsible for determining compliance with these conditions.

**Contact Name – James English - [jenglish@washoecounty.us](mailto:jenglish@washoecounty.us)**

- a) Condition #1: The WCHD has reviewed the above referenced application and recommends the special use permit be approved with a connection to public sewer.
- b) Condition #2: For WCHD to support or recommend approval of the special use permit for an 18 bed system served by an onsite sewage disposal system, the applicant must get in writing from Washoe County Planning Division and the applicable fire agency if the onsite sewage disposal system fails, the current driveway and potential parking spaces may be removed and not replaced for the installation of the repair field per the approved plans and permit requirements.

If you have any questions or would like clarification regarding the foregoing, please contact James English, EHS Supervisor at [jenglish@washoecounty.us](mailto:jenglish@washoecounty.us) regarding all Health District comments.

Sincerely,

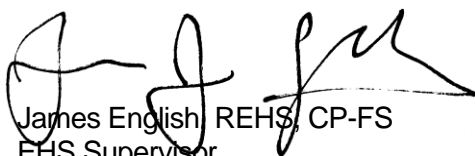

James English, REHS, CP-FS  
EHS Supervisor  
Environmental Health Services  
Washoe County Health District





**WASHOE COUNTY**  
**COMMUNITY SERVICES**  
**INTEGRITY COMMUNICATION SERVICE**

1001 E. 9<sup>th</sup> St.  
Reno, NV 89512  
Reno, Nevada 89520-0027  
Phone: (775) 328-3600  
Fax: (775) 328-3699

June 28, 2023

TO: Julee Olander, Planner, CSD, Planning & Development Division  
FROM: Timber Weiss, Licensed Engineer, CSD  
SUBJECT: Special Use Permit Case Number WSUP22-0019 (Safe Embrace)

**Project description:**

The applicant is proposing to approve a special use permit to allow a 25-bed Group Care Facility. The regulatory zone of the parcel is Low Density Suburban (LDS) and a special use permit is required per Washoe County Code Table 110.302.05.2.

Location: 1995 Ponderosa Drive, APN: 026-422-14.

***The Community Services Department (CSD) recommends approval of this project with the following Water Rights conditions:***

This parcel is within TMWA service area and currently receives municipal water service from TMWA. The applicant shall conform with the requirements of TMWA in regard to water rights and water service. TMWA requires that all water service conditions to be met prior to approval of building permits or business license signoff. Recommend approval of this permit, with written approval or will-serve from TMWA to provide service for the additional use on this property prior to building permit issuance. Please upload TMWA will-serve notice or acknowledgement as a document to the building permit for this project or email the written acknowledgement to [tweiss@washoecounty.gov](mailto:tweiss@washoecounty.gov).

**WSUP22-0019**  
**EXHIBIT B**

**Project Name:** 1995 Ponderosa Revised Special Use Permit  
**Meeting Location:** Sparks Library  
**Meeting Date:** May 23, 2023

**Neighborhood Meeting  
SUMMARY**

**Virtual Meeting Option Provided:**  YES  NO

**Hosted By (Name):** L i s a N a s h **(Company):** Christy Corporation, LTD

**Contact (Email):** Li sa@chri stynv.com **(Phone):** (775) 502-8552 x104

**Public Concerns:**

1. Use is inappropriate for a neighborhood area. Wrong use for this area and industrial look with parking lot makes it worse.
2. Traffic for the site on the private street will continue to cause degradation.
3. Owners have not shown a willingness to keep the property in a good state and no assurances can counter that.
4. Safety is a concern for the neighborhood.
5. Group care facility seems to be a way around what is multi-family housing, and the regulations that govern them.

**Changes Made to Proposal (if applicable):**

1. \_\_\_\_\_
2. \_\_\_\_\_
3. \_\_\_\_\_
4. \_\_\_\_\_
5. \_\_\_\_\_

**Any Additional Comments:**

The neighbors clearly expressed that they do not believe group care facilities are appropriate in residential neighborhoods. They stated that they should not be allowed and should be kept to commercial and industrial zones where they won't degrade neighborhoods.

**From:** [Alferd Knepper](#)  
**To:** [Olander, Julee](#)  
**Subject:** Notice of Neighborhood Meeting 1995 Ponderosa  
**Date:** Tuesday, May 16, 2023 9:47:25 AM

---

[**NOTICE:** This message originated outside of Washoe County -- **DO NOT CLICK** on **links** or open **attachments** unless you are sure the content is safe.]

On Friday, May 12, 2023, we received a Notice of Neighborhood Meeting for a project located at 1995 Ponderosa (Safe Embrace). The notice contains multiple inaccuracies.

First, it is not an existing 18 bed group care facility. Friday afternoon when we called Lisa Nash, she stated the County told them to word it as an existing 18 bed group care facility. In 2019, the City of Sparks and Washoe County unlawfully allowed Safe Embrace to operate an 18 bed group care facility. On 6-20-22, District Judge David A. Hardy declared the following: "A writ of mandamus shall issue against Washoe County directing that it revoke the business license that is allowing Safe Embrace to operate as a group care facility." Therefore, Safe Embrace is now starting the process from scratch. They are requesting to spot zone a single family residence in an existing single family neighborhood into a multifamily civic use group care facility.

Second, the notice says, "You are invited to attend a neighborhood meeting to discuss 1995 Ponderosa Revised Special Use Permit, a proposed development project in your area." Since there is no special use permit in effect to be revised (unless the County issued one without our required knowledge) this statement is also incorrect.

Third, it is not an increase in beds from 18 to 25. Per Judge Hardy's order the number of occupants reverts back to a group home with a maximum of 10 occupants. We cannot find anywhere in the County code that defines number of people allowed as "beds". We ask that the appropriate designation of "occupants" is used so that everyone is aware it includes the number of people allowed at the property at any one time which of course includes children and staff.

Since all of these are misstatements of material facts, we are asking that a new accurate notice be sent to the required notification area and posted on the County website. Otherwise we can only conclude that the County is intentionally trying to sway public opinion which is prejudicial and unfair.

Katie and Alferd Knepper  
775 358 6558

**From:** [Alferd Knepper](#)  
**To:** [Olander, Julee](#)  
**Subject:** SUP 1995 Ponderosa  
**Date:** Monday, July 10, 2023 10:11:43 AM

---

[**NOTICE:** This message originated outside of Washoe County -- **DO NOT CLICK** on **links** or open **attachments** unless you are sure the content is safe.]

Good morning, Julee. We still have not heard anything on our requests from June 13 and June 19 in regard to a landscaping plan and allowable square footage for 25 residents.

Our research shows the detached structures at 1995 Ponderosa Drive cannot be used as habitable space which causes denial of the SUP.

Even if they were allowed as dwelling units, which they are not, code only allows one detached dwelling unit per parcel in Low Density Suburban Regulatory Zones. In addition, the detached accessory dwelling unit shall not exceed 1,500 square feet, or 50% of the total square footage of the main dwelling unit, whichever is smaller. The new addition is over 90% of the square footage of the main dwelling unit. Ref: Section 110.306.25 Detached Accessory Dwellings (a) & (d)

Ref: Section 110.304.15 Residential Use Types:

An accessory dwelling unit must have a kitchen – these do not.

The detached garage is defined as a detached accessory structure which does not allow habitation. This was pointed out by the Building Department in 2018 in their review of the building permit application for the new structure.

Ref: 110.304.15 (a) (2) and (3)

The new extension is detached by definition as it only has a breezeway, not a common wall, to the main structure. Therefore it is a detached accessory structure as it does not have a kitchen. It also does not allow habitation per code.

Ref: 110.304.15 (a) (1)

If Planning does not agree with the above, please let us know why as the code appears to be clear to us.

Thank you for your help.

Al & Katie Knepper

**From:** [Alferd Knepper](#)  
**To:** [Olander, Julee](#)  
**Subject:** SUP 1995 Ponderosa  
**Date:** Tuesday, July 11, 2023 1:19:13 PM

---

[**NOTICE:** This message originated outside of Washoe County -- **DO NOT CLICK** on **links** or open **attachments** unless you are sure the content is safe.]

Project Description Page 8 states, "It is requested that the existing 6-foot wood fences be allowed to remain." We would like to object. Safe Embrace needs to erect a proper fence in compliance with code since they have proven they will not repair the existing wooden fencing – if it needs repairs the adjoining neighbors either need to repair the fence themselves or it doesn't get fixed. The wooden fence adjacent to the rear of the east property was damaged years ago during their construction (see picture). The neighbor complained (and has since passed away) to no avail. The neighbors to the south had to pay to fix the wooden fence themselves when Safe Embrace refused to do so. Code provides for a durable attractive non wood fence buffer between Safe Embrace and the adjoining properties along with specific height requirements. The existing fence does not meet these criteria.

Safe Embrace erected a NEW wooden fence on the west property boundary in violation of code in the summer of 2022 even though they were aware (or should have been aware) of code requirements.

Picture of side/rear of property at 1995 Ponderosa Drive taken 7-1-23 showing fence in disrepair.



Thank you for putting this objection on record for the Board of Adjustment.

Al & Katie Knepper

**From:** [Alferd Knepper](#)  
**To:** [Olander, Julee](#)  
**Subject:** 1995 Ponderosa SUP  
**Date:** Thursday, July 13, 2023 9:35:36 AM

---

[**NOTICE:** This message originated outside of Washoe County -- **DO NOT CLICK** on **links** or open **attachments** unless you are sure the content is safe.]

Julee, could you please add this to the documentation for the Board of Adjustment?

Safe Embrace is similar to a short term rental where residents are transient and as such would be a Tier 3 (21 or more persons – Safe Embrace has 18 residents and 4 staff equaling 22). The short term rental is grouped in the same category as a group home. Washoe County acknowledges Safe Embrace is NOT APPROPRIATE in section 110.304.15 (d) (3) which states:

“A Tier 3 STR has a maximum occupancy of 21 or more persons. This highest tier of STRs is still operated out of a pre-existing dwelling unit, but due to the high number of occupants, is expected to have more significant impacts to surrounding properties. As a result, it is considered inappropriate to be located in residential regulatory zones, but may be appropriate on properties with commercial regulatory zones that are located nearer tourist and commercial services.”

Thanks,  
Al & Katie Knepper



**From:** [Alferd Knepper](#)  
**To:** [Olander, Julee](#)  
**Subject:** 1995 Ponderosa SUP  
**Date:** Thursday, July 13, 2023 11:26:23 AM

---

[**NOTICE:** This message originated outside of Washoe County -- **DO NOT CLICK** on **links** or open **attachments** unless you are sure the content is safe.]

Julee, we would also like this added to the documentation for the Board of Adjustment.

SUP Application Finding #8, "Are there any restrictive covenants, recorded conditions, or deed restrictions (CC&Rs) that apply to the area subject to the special use permit request? (If so, please attach a copy.)" is marked "no". Safe Embrace admits and acknowledges there are not only deed restrictions on the property but they are in violation of them (per Washoe County District 3 court hearing 7-7-23). This is another factual error (and was pointed out in the May 23<sup>rd</sup> neighborhood meeting since it was also in error on a previous application). It has to be assumed that Safe Embrace is purposely attempting to hide the fact from the Board that multiple deed restrictions apply to their request.

A copy of their deed restrictions was included in our document sent last year which has been added to the record.

While the County does not enforce deed restrictions we have been told they take them into consideration when reviewing a special use permit. (Why else have the question on the application?) In fact, there are instances where the County **REQUIRES** an applicant to **PLACE** a deed restriction on their property in order to obtain approval. (For example, Section 110.306.10 (h) - "Deed Restriction Required for Connection to Water or Wastewater Facilities")

Thanks  
Al & Katie Knepper

**From:** [Alferd Knepper](#)  
**To:** [Olander, Julee](#)  
**Subject:** WSUP22-0019  
**Date:** Monday, July 24, 2023 9:49:59 AM

---

[**NOTICE:** This message originated outside of Washoe County -- **DO NOT CLICK** on **links** or open **attachments** unless you are sure the content is safe.]

Julee, would you please forward this to the Board of Adjustment for the 8-3-23 hearing.  
Thanks  
Al & Katie Knepper

**THIS IS A SUPPLEMENT TO PAGES 4 & 5 OF THE "OBJECTIONS TO WSUP22-0019" SUBMITTED IN 2022 AND RESUBMITTED FOR THE AUGUST 3, 2023 HEARING. THE BELOW IS AN UPDATED CLARIFICATION FOR THE CURRENT SUP (WHICH IS ALMOST IDENTICAL TO THE INITIAL ONE THAT WAS WITHDRAWN IN 2022.)**

## **Washoe County must follow its code and deny Safe Embrace's SUP application for knowingly making false and material misrepresentation of facts:**

Finding #3 states, (a) "The care facility has been in existence for over 20 years." And (b) "The site was previously approved and operated under the City of Sparks before it was determined that the permitting should have been completed under Washoe County. This permit is to correct that inadvertent oversight for an operating site."

Special Use Permit Application Supplemental Information # 4 states, "This use has been in existence for over 20 years and the site is appropriate to the use."

Safe Embrace was a group home (allowed in single family residential neighborhoods) until 2019 when they were illegally granted a business license for a group care facility. It has NOT been a group care facility in existence for over 20 years. In fact during a court hearing on 7-7-23, the City of Sparks told the court they could NOT have allowed Safe Embrace to operate as a group care facility for victims of domestic violence in 2019 if it had gone to the Sparks Planning Commission as was required. Since the property was under the Sparks Sphere of Influence at the time, that was the required procedure. Safe Embrace is WELL AWARE they have not been a group care facility for over 20 years and yet they are trying to make this Board believe they are just continuing on as "business as usual", which is far from the truth. There was NO inadvertent oversight and they know it (see note below). The above claims simply are not true.

Special Use Permit Application Supplemental Information # 8 states there are no deed restrictions that apply.

Not only is Safe Embrace well aware of the deed restrictions that apply (we are in litigation over them and at the court hearing on 7-7-23 Safe Embrace admitted they are in violation of these deed restrictions), but Safe Embrace was told at the May 23, 2023 Neighborhood meeting that it is a question on the SUP application. (Ref: May 23 audio approximately 28 minutes in) At this meeting, Christy Corp said Deed Restrictions are not public record (when in fact they are a recorded document) and they also said there was NOT a question about deed restrictions on the application. When we said there IS a question and the previous application was marked "no" (the current application had not been completed on May 23) their response was they would get it clarified. Yet Safe Embrace STILL marked #8 "no" – no deed restrictions apply. Again, Safe Embrace does not want the Board to be aware that permitting the

SUP violates these deed restrictions (the County has a copy of Safe Embrace's deed restrictions in the original "Objection" document). While the County does not enforce deed restrictions, we were told by Planning that they take them into consideration in the permitting process. In fact the County REQUIRES deed restrictions be placed in certain instances (such as detached structures being connected to water or wastewater facilities, Section 110.306.10) so that homeowners are protected.

By pretending they have been operating a group care facility for the last 20 years, Safe Embrace does not want the Board to take into consideration the impact a motel like civic/commercial business will make (and has made) to a unique single family neighborhood on a private drive. Since you already have our original "Objection" document we will not repeat the rest of the multiple false statements in the current SUP application.

Safe Embrace is knowingly making multiple false statements and misstating material facts. They are trying to convince the Board this is just a "rubber stamp" for something already in existence when nothing is further from the truth.

One of the many reasons WSUP22-0019 should be denied is because it is filled with material false statements and omissions in violation of Washoe County Code 125.140. The non-exclusive remedies for such violations are set forth in Washoe County Code 125.150. Here, in addition to whatever administrative and civil penalties the enforcement official deems necessary, the application should be denied outright.

NOTE: On 6-20-22, a writ of mandamus was issued by the Washoe County District Court against the City of Sparks directing that it revoke the approvals related to the November 21, 2017 development application submitted by Safe Embrace, the approvals related to the WBLD18-104678 building application (the four bedroom addition) , and the certificate of occupancy issued as a result thereof. A writ of mandamus was also issued against Washoe County directing that it revoke the business license allowing Safe Embrace to operate as a group care facility.

# **OBJECTIONS TO WSUP22-0019**

**Submitted by:**

**Alferd and Katherine Knepper,  
Ryan and Tami Wittich,  
Carlos and Samantha Gonzalez,  
Mario and Marcia Frugoli,  
John and Gina Bird,  
John and Mike Jeffrey,  
Grant Garrison,  
James Ferris,  
Robert Georgeton,  
Nancy and Marvice Beutel**

## Table of Contents

I.	THE SUP MUST BE DENIED BECAUSE ITS PROPOSED USE WILL VIOLATE MULTIPLE DEED RESTRICTIONS .....	3
II.	THE SUP APPLICATION CONTAINS MULTIPLE FALSE STATEMENTS .....	4
III.	WASHOE COUNTY CANNOT MAKE THE NECESSARY FINDINGS UNDER SECTION 110.810.30 TO APPROVE THE SUP APPLICATION.....	5
A.	The County cannot find that the SUP is consistent with the policies and maps of the Comprehensive Plan Elements and the Area Plan in which the property is located.....	5
B.	The County cannot find that there are adequate utilities, roadway improvements, sanitation, water supply, drainage, or other necessary facilities.....	6
C.	The County cannot find that the site is physically suitable for the proposed use and for the intensity of development. ....	6
D.	The County cannot find that issuance of the permit would not be detrimental to the public safety, have a detrimental impact on adjacent properties, or be detrimental to the character of the surrounding area. ....	7
i.	THE PROPOSED USE IS DETRIMENTAL TO THE PUBLIC SAFETY .....	7
ii.	THE PROPOSED USE IS INJURIOUS TO THE PROPERTY OR IMPROVEMENTS OF ADJACENT PROPERTIES .....	8
iii.	SIGNIFICANTLY DETRIMENTAL TO THE CHARACTER OF THE SURROUNDING AREA8	
IV.	THE PROPOSED USE VIOLATES MULTIPLE CODES .....	9
1.	Article 412 Landscaping .....	9
2.	Article 322 Group Care Facilities .....	11
3.	Article 306 ACCESSORY USES AND STRUCTURES .....	12
V.	NO MORE THAN 18 OCCUPANTS ARE ALLOWED AT THE PROPERTY..... <b>Error!</b> <b>Bookmark not defined.</b>	
	ADDITIONAL COMMENTS FROM TAMI & RYAN WITTICH .....	15
	ADDITIONAL COMMENTS FROM NANCY AND MARVICE BEUTEL .....	17

**I. THE SUP MUST BE DENIED BECAUSE ITS PROPOSED USE WILL VIOLATE MULTIPLE DEED RESTRICTIONS**

Contrary to the false statement in section 8 of WSUP22-0019, there are deed restrictions recorded against the Property that run with the land.

8. Are there any restrictive covenants, recorded conditions, or deed restrictions (CC&Rs) that apply to the area subject to the special use permit request? (If so, please attach a copy.)

Yes  No

Applicant is very familiar with the existence of the deed restrictions that encumber its property as litigation has been pending in the Second Judicial District Court since October of 2021 regarding whether Applicant’s construction of the addition on their property and its changed use violates these deed restrictions. This issue remains pending with the Court. For this reason alone, the SUP should be denied, at minimum, until a judicial determination has been made concerning the CC&Rs.

For reference, the deed restrictions can be found in the Joint Tenancy Deed recorded against the Safe Embrace Property (APN 026-422-14) as Document Number 330617, which is attached hereto as Exhibit 1.

Importantly, the following deed restrictions restrict the property:

1. No part or portion of said real property shall at any time be used for business or commercial purposes.
2. No multiple family residences shall at any time be constructed or maintained thereon.
3. No barn shall be maintained thereon having a capacity for more than two horses with one tack room attached and no kennels shall be maintained thereon for more than two dogs.
4. No building shall be erected or constructed upon any part or portion of said property for residential purposes unless constructed of brick.
5. No building shall be erected or constructed upon any part or portion of said property for residential purposes having less than 1450 square feet exclusive of open porches, attached garages and basements. (The main portion of the detached garage, which in total is less than 1450 square feet, has been improperly converted to residential use without proper permitting and in violation of the deed restrictions.)

Again, the Court has not disposed of the issue of whether Applicant’s additional structure or proposed use violates the deed restrictions. The Planning Committee and/or Board of Adjustment should not circumvent the Court’s authority or allow a restricted use.



## II. THE SUP APPLICATION CONTAINS MULTIPLE FALSE STATEMENTS

Under the Administrative Authority, County Code 125.140 provides:

- (1) It is unlawful for a person to violate, fail to comply with, or assist in the violation of a provision of the Code or of any term and condition of a county approval (including, without limitation, any permits or licenses) or any order issued by an enforcement official, a hearing officer, or the board, and *is unlawful for a person to knowingly make or submit a false statement, document, or material omission in connection with an application or procedure required by this chapter.*

(emphasis added).

WSUP22-0019 contains multiple, material, false statements and therefore violates County Code 125.149. First, as noted above, Safe Embrace wrongfully indicated that there were no deed restrictions that apply to the Property. This cannot be categorized as anything other than a knowingly false statement. Further, additional false statements or material omissions contained in the WSUP22-0019 are set forth below:

1. Pages 5 and 6 discuss the zoning maps and similar applicable property information. This section omits the fact that the Property is situated in PJ Kelly's subdivision and that each house located therein is governed by a set of deed restrictions.
2. The following statement on page 7 is false – "There is a pet shelter that can house 3 dogs and 6 cats/small animals." There are enclosures for 4 dogs and 8 cats/small animals.
3. Page 7 also states, that "[t]he garage located on the subject property was converted to a living space in 2007. The setbacks are met for the property with the exception of the converted existing detached garage on the west property boundary. This building was converted in 2006 into work and office space." However, there are no building permits converting the garage to a living space in 2007. In 2006, it appears a building permit was issued for only a small office and bath portion and storage area of the detached garage. The storage area has no permit for conversion to a living space.
4. The statements on page 8 regarding parking are inaccurate. Parking does not meet the requirements for the number of vehicles that actually visit the property, nor is it in compliance with the architectural drawings submitted for the improper expansion.
5. The statements on page 8 regarding landscaping omit the current condition of the landscaping at the property. Applicant neglected the landscaping for the past four (4) years, which resulted in one of the trees dying and falling onto a neighbor's house. The existing landscaping does not meet the requirements for a group care facility.

6. SUP Application Supplemental Information states:

What are the anticipated beneficial aspects or affects your project will have on adjacent properties and the community?

The project is a very necessary and vital service to the community.

Notably absent in response to question number 5 is what anticipated beneficial aspects or affects the project would have on **adjacent properties**. This application was completed after the neighborhood meeting on July 18, 2022, where the adjacent property owners discussed their concerns about the affects of any SUP.

Simply stated, the direct answer to the question posed in item 5 is that there are NO beneficial aspects to adjacent properties – only detrimental ones. Seventeen (17) property owners of adjacent properties are currently involved in litigation with Applicant over nuisance claims related to problems created by the inappropriate expansion. (See Exhibit 2 attached hereto which is a filed stamped copy of Plaintiffs’ Complaint.)

WSUP22-0019 should be denied because it is filled with material false statements and omissions in violation of Washoe County Code 125.140. The non-exclusive remedies for such violations are set forth in Washoe County Code 125.150. Here, in addition to whatever administrative and civil penalties the enforcement official deems necessary, the application should be denied outright.

**III. WASHOE COUNTY CANNOT MAKE THE NECESSARY FINDINGS UNDER SECTION 110.810.30 TO APPROVE THE SUP APPLICATION**

In order to approve the SUP, the County must be able to make certain findings in four applicable specified areas pursuant to Section 110.810.30. As the County will not be able to satisfy the requirements of Section 110.810.30, the application must be denied.

**A. The County cannot find that the SUP is consistent with the policies and maps of the Comprehensive Plan Elements and the Area Plan in which the property is located.**

Under this heading in the application, Applicant states that “[t]he project is an existing operation and is appropriate for the area.” This is a deceptively inaccurate statement. The use sought in the application, that of a “25-bed group care facility,” is NOT an existing operation. On June 20, 2022, a Washoe County District Judge found that the operation as a group care facility was improper and the business license authorizing it to operate as a group care facility was revoked effective August 15, 2022. The property’s existing use prior to the improper expansion was a single family residence, consistent with the applicable zoning. It had no permits or licenses for a use as anything other than a group home, which is a single family use. Transformation of this property to a group care facility is NOT appropriate for the middle of this subdivision of single

family residences which are governed by deed restrictions (many of which Applicant has violated). (See Exhibit 3 attached hereto which is a filed stamped copy of the Court's Order.)

**B. The County cannot find that there are adequate utilities, roadway improvements, sanitation, water supply, drainage, or other necessary facilities.**

Ponderosa Drive is a private drive that is not maintained by the County. Since applicant improperly expanded its operations in 2018, the road has deteriorated exponentially due to the increased traffic daily to and from the facility, including large construction trucks for a period of time. Applicant has refused to fix any of the potholes or maintain the road in any way. There are no sidewalks for the increased foot traffic. It is dangerous for all of the residents on Ponderosa Drive to walk down the road, dodging numerous potholes and an increased number of vehicles for this improper operation of a group care facility in a single-family residential neighborhood. Improvements to the road are necessary and critical. Since Applicant is responsible for this crisis, it should be responsible for fixing the road whether the SUP is approved or not. However, no such repairs of maintenance or repairs to the road have ever been performed by Applicant.

Furthermore, the Property is NOT on sewer, but is serviced by 2 septic tanks. Neighboring properties are on a rather shallow well and shares a property point with 1995 Ponderosa. The neighboring properties are concerned about a failure that would affect their ground water.

**C. The County cannot find that the site is physically suitable for the proposed use and for the intensity of development.**

The special use application states that “[t]he care facility has been in existence for over 20 years,” which is completely misleading. Prior to July 2019 the use was that of a group home, not a care facility.<sup>1</sup> Additionally, the district court found that the expansion of the property and use as a group care facility were improper. On page 8, the application states, “[t]he site was previously approved and operated under the City of Sparks before it was determined that the permitting should have been completed under Washoe County. This permit is to correct that inadvertent oversight for an operating site.” Id. This language is inaccurate and suggests a mere clerical error occurred. The judge determined that the City's approvals of the project were an abuse of discretion because notice to the neighboring residents and an opportunity for them to be heard on the issue was a requirement of any approval or denial of the development application. Washoe County then issued a business license for the property to operate as a group care facility based on the City of Sparks' improper approvals. The City's approvals have been revoked as improper and the business license allowing the property to operate a group care facility has been revoked as improper.

Furthermore, the property has a kennel with crates for 4 dogs and 8 cats, which is not suitable for a residential neighborhood with houses just feet from the kennel and adjoining dog run. Dogs bark at all hours. They have been kept in conditions that are uncomfortable at best, causing the animals to cry in distress. There is no building permit on file for this arrangement, which equates to a commercial kennel.

---

<sup>1</sup> Although a group home use is proper in a single family residential neighborhood, we believe the property was NOT operating within the definition of a group home prior to 2019 since code at the time was very clear a group home was only for non-transient residents.



**D. The County cannot find that issuance of the permit would not be detrimental to the public safety, have a detrimental impact on adjacent properties, or be detrimental to the character of the surrounding area.**

***i. THE PROPOSED USE IS DETRIMENTAL TO THE PUBLIC SAFETY***

In the past, residents have given the 1995 Ponderosa address to their abusers. This Special Use Permit Application is called “1995 Ponderosa” and has been given much public attention by Safe Embrace. Residents of properties have a genuine concern about their safety with the

disclosure of the location. Even Safe Embrace’s director publicly addressed this concern when she publicly commented as follows:

“West says she is mainly concerned with the release of the shelter's address via public records. The shelter's address has remained confidential for almost two decades to protect the survivors from their abusers. ‘That puts all of our victims at risk, their children at risk, our team members are now at risk,’ she said’ She added: ‘Now everyone is aware of where Safe Embrace shelter is located and there is no way to mitigate that -- there is no way to avoid that.’”

NO ONE on Ponderosa drive is safe from possible interaction with the abusers - not just the inhabitants of 1995 Ponderosa. This safety concern is compounded by the fact that Ponderosa Drive is a dead end private drive with only ONE ingress/egress to a busy street.

Since Ponderosa Drive is a private drive, Washoe County cannot enforce traffic violations or parking violations. Vehicles often exceed the 15 mph posted speed limit. On one occasion, some Ponderosa residents were walking on the street with their dog when a car sped by. They called for it to slow down, but it did not. When it got to the end of the dead end street and had to turn around, it aimed at them as if it would hit them. Another neighbor took a video and they all called the sheriff. The deputy who came out was sympathetic but said there was nothing he could do as it was private property. Not being able to enforce traffic violations, especially when abusers are apt to speed down the private street (as they have in the past, including turning around in residents’ private driveways) is definitely a detriment to the safety of the other residents on Ponderosa Drive and there is no way to mitigate that.

***ii. THE PROPOSED USE IS INJURIOUS TO THE PROPERTY OR IMPROVEMENTS OF ADJACENT PROPERTIES***

This property was recently removed from the City of Sparks’ sphere of influence. Per the City of Sparks Use Table 20.02.013, housing services including short term emergency shelter for victims of domestic violence, sexual assault or child abuse are prohibited in all single and multi family residential zoned areas in the City of Sparks. In Sparks, this type of facility has been deemed injurious to the property or improvements of adjacent residential properties. Although this property is now in Washoe County’s jurisdiction, and these issues are not specifically addressed in Washoe County Codes, the logic and reasoning remains the same, as the City of Sparks’ residential properties share a property line with 1995 Ponderosa. That is, being injurious in any single or multi family residential zoned area in the City of Sparks makes it no less injurious in the little island of single family residential homes in Washoe County which is totally surrounded by the City of Sparks.

***iii. SIGNIFICANTLY DETRIMENTAL TO THE CHARACTER OF THE SURROUNDING AREA***

The residents of Ponderosa Drive appeared at the neighborhood meeting on July 18, 2022 and discussed the detrimental effects the improper group care facility had on their lives. Those concerns are not remedied through the SUP application.

Ponderosa drive is part of the PJ Kelly’s Ranch subdivision. All the lots on Ponderosa are protected by essentially the same deed restrictions that have been in effect for over 60 years. These

deed restrictions are meant to ensure the character of the subdivision is not compromised. The Property, which is akin to a transient 9 unit motel, complete with dog kennel, cattery, therapy room, “Kids Klub”, and computer lab, in the middle of the residential neighborhood zoned E-1 single family is neither in character with the surrounding area, nor in compliance with the deed restrictions.

Applicant conveniently leaves out of its SUP application that the commercial properties it lists as being similar to the Applicant’s property are outside of PJ Kelly’s Ranch subdivision, which are encumbered by certain deed restrictions. The application’s reference to the apartment buildings and commercial properties OUTSIDE of PJ Kelly’s Ranch subdivision as evidence as to why Applicant should be allowed to operate in this single family residential neighborhood encumbered by deed restrictions is totally absurd. (The same as arguing commercial properties outside of Arrow Creek subdivision or Pebbles subdivision is part of their “surrounding area” and therefore these types of uses would be appropriate within THEIR subdivisions.) The City of Reno has similar properties with charitable services such as the Eddy House (MU), the Ronald McDonald House (MU) and the Veteran’s Guest House (MF14). Those properties, like the Applicant’s property, provide great services to our community. However, they are not appropriate for single-family residential zoned areas.

Moreover, Applicant’s residents are transient. Since its business license to operate a group care facility has been revoked, the County is required to review Safe Embrace’s requested use as an entirely new request, not a continuance of prior improper use. The use proposed in the SUP is no different than a monthly motel – with a 100% change in residents every 90 days or less. Having transient male/female victims, who may suffer from mental health issues and/or substance abuse is a detriment to the safety of the neighborhood. For example, two teenage residents of Ponderosa Drive have been approached by one of the Property’s occupants asking for illegal drugs. Additionally, one neighbor who lives directly next door to the Property described during the neighborhood meeting how one of the individuals at the Property shrieked and screamed for hours throughout the night over a 2 week period saying things like, “You have to let me out. You have to let me go,” and other things that were indiscernible. This was obviously very disturbing and just an example of reasons why the proposed use of the Property is detrimental to the character of the neighborhood.

#### **IV. THE PROPOSED USE VIOLATES MULTIPLE CODES**

##### **1. Article 412 - Landscaping**

Applicant allowed all the mature trees on the east and west property lines to die from lack of water in violation of Section 110.412.25 (c), which calls for the preservation of significant trees. Applicant also removed all the trees and landscaping from the rear yard. No new trees have been planted as required by code. The Property is also in violation of Section 110.412.40, which provides a detailed description of required yards adjoining streets as well as landscaped buffers when civic uses are adjoining residential uses (which is improper in this instance). Applicant has never been in compliance with these code requirements, despite improperly operating as a civic use for the past few years.



Additionally, Section 110.412.4(d), Screening Adjoining Residential Uses, states the following: “When a civic or commercial use adjoins a residential use, a solid decorative wall or fence shall be erected along the entire length of the common property line. This wall or fence shall be at least 6 feet but not more than 7 feet in height. The wall or fence shall be constructed of durable materials, such as stone, concrete, metal, synthetic or vinyl. **Wooden fences are not acceptable.**” (Emphasis added). The property has never been in compliance with this code – in fact when the existing fences have needed repair, Applicant refused to repair them, causing the adjoining neighbors to do the repairs themselves. Additionally, not all the fencing is 6 to 7 feet as required. Photos of different stages of the fencing are included below.

Picture taken April 29, 2020 (no fence – west side)



Picture taken June 29, 2022



For the first time in over a decade, in June 2022, and most likely in anticipation of this SUP application, Applicant erected a NEW fence (NOT replacing portions of an existing fence) made TOTALLY OUT OF WOOD which is directly contrary to the express language of the code. If

Applicant was going to erect a brand new fence, why wouldn't they use the proper materials? This is consistent with their historic behavior of asking for forgiveness, not permission.

Picture taken August 9, 2022 (improper new fence)



## 2. Article 322 - Group Care Facilities

Section 110.322.10(i), Parking Plan, states, “[t]he applicant shall develop and will implement a parking plan indicating the maximum number of vehicles to be parked on and off the site, projected needs for parking at the site, and means to satisfy the projected needs.” There is no room for and no parking plan for more than 10 vehicles (which is an increase of 2 from what Applicant originally proposed to the City of Sparks). Furthermore, the original parking plan did NOT convert the side yards to parking lots, rather kept these as landscaping and supplied parking places on the circular drive as well as in front of the garage.

The below pictures (from October 26, 2021) demonstrate that there is not adequate parking in this single-family residential neighborhood for the facility Applicant is attempting to operate.







### **3. Article 306 – Accessory Uses and Structures**

Section 110.306.35(e), Trash Storage Method and Location, states that trash enclosures shall be screened from view from public rights-of-way. In answer to questions asked at the Neighborhood meeting on July 18, 2022, Applicant’s representative stated that the 5 trash/recycle bins “will now be stored behind the fencing and will not be visible from the street any longer.” As of the date of this opposition (August 29, 2022) Applicant has not followed through with this promise is still in violation of Section 110.306.35(e). This is yet another example of Applicant’s false promises that are made only to further their goal of obtaining the requested permits and without any intention of following through. Not only does Applicant continually ignore code, but they show a total disrespect/contempt for their neighbors.

**V. NO MORE THAN 18 OCCUPANTS ARE ALLOWED AT THE PROPERTY.**

As you can see from the below calculations, the Property cannot have more than 18 occupants, even if it were a group care facility, which it is NOT allowed to operate as per court order. Applicant attempts to justify allowance of up to 25 beds by using the square footage of 3 improper areas: the attached garage which is not livable space, the portion of the detached garage that is outside the office area (the only approved livable space) and the improper expansion, which has had its building permit and certificate of occupancy revoked by court order (See Exhibit 3).

Per code, the number of occupants allowed is 6 occupants for the first 1200 square feet and 150 square feet is required for each additional occupant. The following calculations are based on the plans submitted for the construction of the new addition and an approximation of the number of feet for the main house. Any errors in the calculations of the total square footage should not be significant.

It is unknown how much legally livable square feet is in the detached garage, but a building permit has only been issued for a small office/bathroom area. The bathroom area of course is not livable, only the office space. The rest of the unit is non-livable storage area per above since it was never legally converted to a livable space.

Non-Livable Space Detached Expansion, if it were currently legal, which it is not:

Baths & Closets	50' x 11.34'	= 567 square feet
Storage	23.17' x 12.42''	= <u>287.77 square feet</u>
TOTAL NON-LIVABLE DETACHED EXPANSION		= 854.77 square feet

Non-Livable Space Main House:

Hallway/hallway closet	28' x 3'	= 114 square feet
1 <sup>st</sup> Bath/closet	14' x 8'	= 112 square feet
2 <sup>nd</sup> Bath/closet	13' x 6'	= <u>78 square feet</u>
TOTAL NON LIVABLE MAIN STRUCTURE:		= 304 square feet

Total square footage of main house is 2131 square feet minus 304 non livable square feet gives a total of 1827 livable square feet.

Total square footage of the improper detached expansion is 1925 square feet minus 855 non livable gives a total of 1070 livable square feet if it were allowed.

TOTAL LIVABLE SQUARE FEET IN BOTH UNITS = 2897 square feet.

For 2900 square feet, the Property can only legally have 16.7 occupants. From the plans on file with the County, the detached garage could not have enough legally livable space for more than one or two more occupants which is most likely why the City of Sparks changed the total from a high of 32 approved down to 18.



**ADDITIONAL COMMENTS FROM TAMI & RYAN WITTICH**

We are neighbors of the 1995 Ponderosa Drive property and would like to respond to the Special Use Permit submitted by Safe Embrace. We are completely against any special use permit being approved by Washoe County. This is a quiet, residential neighborhood which all properties are (or were) zoned “E-1” which only allows for up to 10 people living in any property. It is also located on a private street that is to be maintained by the residents. Allowing more than 10 people to reside on one property would create a hardship on the other neighbors to maintain the street and deal with the additional traffic and security issues.

To respond to the Special Use Permit application directly we offer the following comments:

Figure 3 – this Existing Site Features photo was taken some time ago. Safe Embrace has already changed this significantly. The tree line on the east side of the property has been removed and the area covered with rock. It is currently being used for parking and there are cars parked there on most days. See below photo.



Figure 4 – This is a “staged” picture that shows the west side of the property. That is not how the property usually looks. Cars are usually parked all over and not usually in a nice line as noted in the picture. There are no pictures of the east side either showing there are no trees and cars parked on the rock that has been installed.

Page 8, 2<sup>nd</sup> paragraph – the comment “existing trees will be retained” does not match the pictures provided. All but the main tree in the center grassy area and the other trees outside the fence on either side of the circular driveway have already been removed and rock has been put in all areas other than the smaller grassy area in the center of the front. The rest of the “yard” has been used for parking and it looks like a commercial facility in its current state.

Page 8, Item 1 – A group care facility is not appropriate for the area. This is a residential neighborhood on a private road and a 25 bed facility is not appropriate for a single-family residential neighborhood.

Page 8, Item 3 – A group home was approved and in existence prior to 2017-2018 when the expansion began. Sparks circumvented citizen notices and public meetings and approved the care facility which has been challenged since the surrounding neighbors realized what was happening. A care facility should never have been approved for this area and is not allowed under Sparks or Washoe County codes.

Page 9, Item 4 – Yes, Safe Embrace does provide a vital community service and should continue to provide that in areas approved for such. To operate a group care facility they should establish that in an area which allows for multi-family zoning.

Appendices, Special Use Permit Supplemental Information, Item 4 – Yes, this home had been operated as a group home only for over 20 years, not as a 25 bed group facility which is not allowed.

Appendices, Special Use Permit Supplemental Information, Item 7 – The “attached report” is not truthful. There is no mention of parking on the east side of the property where they park now and the pictures show the trees, which have been removed and rock installed.

Appendices, Special Use Permit Supplemental Information, Item 8 – This is checked “no” and should be checked “yes”. See attached. There are deed restrictions on this property, with the first being it cannot be operated as a “business or commercial facility”.

We respectfully request that this Special Use Permit be denied.

Thank you,  
Tami & Ryan Wittich  
(775)323-5224 (calls)  
(775)771-6161 (texts)



## **ADDITIONAL COMMENTS FROM NANCY AND MARVICE BEUTEL**

My residence shares a back fence with Applicant. Applicant's prior improper use of its Property and the use for which it seeks through this special use permit application, does not belong in a residential neighborhood because they have proven over and over that it does not intend to behave as good neighbors or abide by the regulations that govern their Group Care Facility. As we moved into our home in 2018, Applicant has had over four years to demonstrate this neighborliness to my sister and me. It has been a long four years.

Every interaction that I've had with the people at Safe Embrace has been about the dogs boarded in the backyard (except for the fence replacement issue). Since the kennel and dog run are so close to the back fence our properties share, the dogs are practically in our backyard. I've tried to talk to Safe Embrace about excessive barking, dogs left in the shade-less run for hours in the hot sun, and general neglect of the animals. If I even find someone to talk to, the reoccurring response has been that they are not allowed to talk to me, and I must go through the Advocate. However, I cannot find out who the Advocate is or how to get in touch with this elusive entity. The last time I tried to communicate with someone on the property, I went to the front door to inform them of a dog that had been barking and crying in the run for four or five hours. It was a very hot day. I was told by the woman in charge that she was calling the police because I was trespassing. I waited for the police to come with my sister in my car which was parked across the street on Poderosa. The lady in charge and another resident came out onto the front lawn, walked up and down the fence line calling my sister and me vulgar names. They took multiple pictures of us, my car, and the license plate. This is not the behavior of good neighbors.

There are other areas where Safe Embrace has failed to fulfill their obligations as a Group Care Facility. They are required to have a neighborhood response program where the owner or permittee of the property will be available at a fixed time on a weekly basis to discuss neighborhood problems relative to this Group Care Facility. There has been no such program. The facility is required to maintain a 6-7-foot fence between it and adjacent residential properties. When we had to replace the fence we share, Safe Embrace did not even offer to pay for half the expense. Another stipulation is that facility have a landscape screen of trees along the fence line to provide some privacy and serve as a noise buffer. There are no trees along our shared fence. In fact, the one tree that was there and provided a little shade for the kennel was cut down.

From my sister and my point of view, the people occupying the Safe Embrace facility have not been anything resembling good neighbors for the past four plus years since we moved into the neighborhood starting with the illegal building of the motel wing.

Marvice Beutel

**Public Notice**

Washoe County Code requires that public notification of a Special Use Permit be mailed to a minimum of 30 separate property owners within a minimum 500 foot radius of the subject property a minimum of 10 days prior to the public hearing date. This proposal was noticed within a 500-foot radius of the subject property, noticing 53 separate property owners a minimum of 10 days prior to the public hearing date.

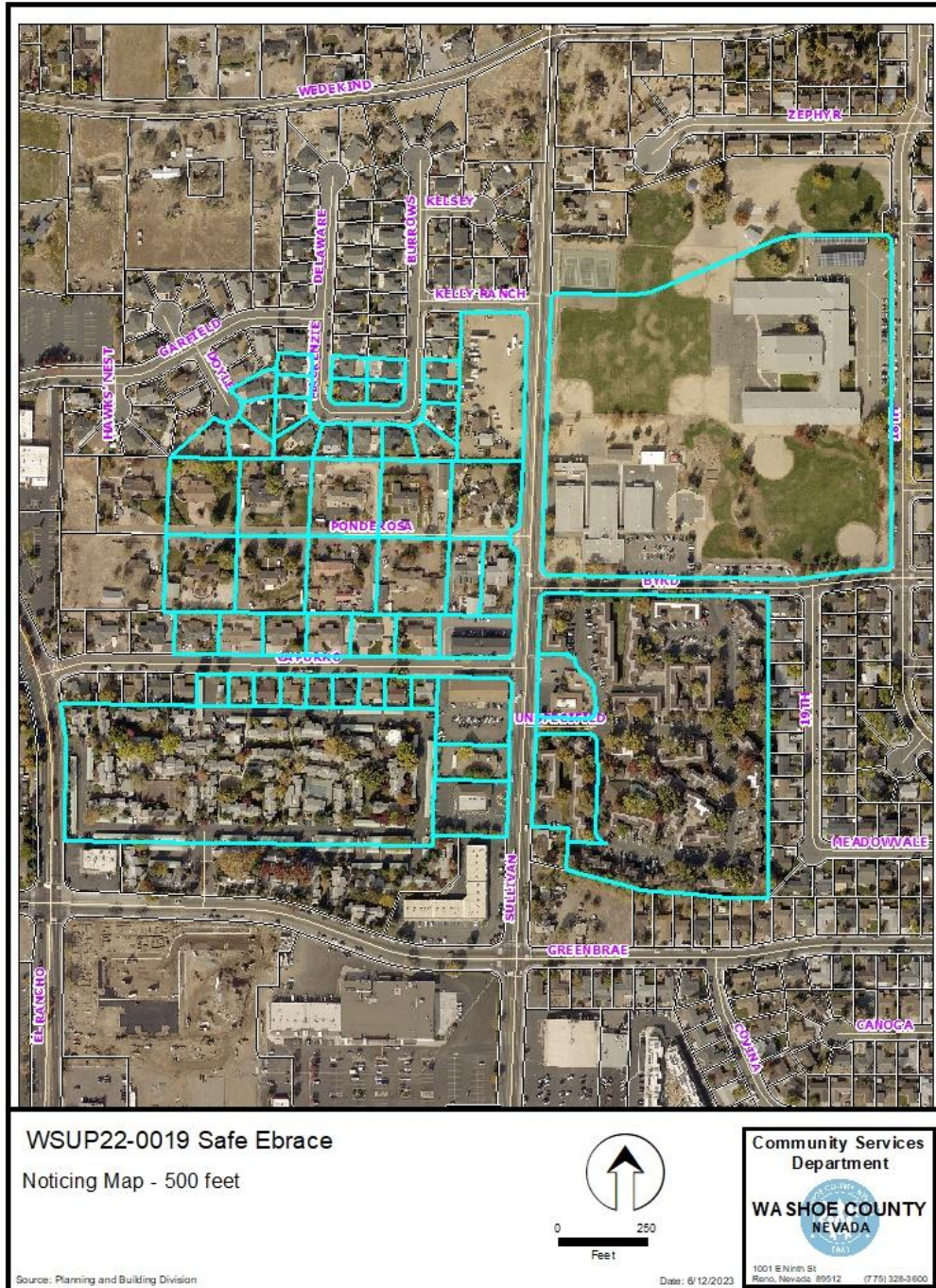

**Public Notice Map**

**Special Use Permit Case Number WSUP22-0019**

# SAFE EMBRACE SPECIAL USE PERMIT



Prepared by:



August 8, 2022  
Revised June 8, 2023

# **SAFE EMBRACE**

## **Special Use Permit**

**Prepared for:**

Safe Embrace  
220 S. Rock Boulevard, Ste 7  
Reno, NV 89502

**Prepared by:**

Christy Corporation, Ltd.  
1000 Kiley Parkway  
Sparks, Nevada 89436  
(775) 502-8552

**August 8, 2022**

**Revised June 8, 2023**

## Table of Contents

Introduction.....	1
Project Location.....	1
Existing Conditions .....	2
Project Description/Request .....	7
Special Use Permit Findings.....	9

### List of Figures:

Figure 1 - Vicinity Map.....	1
Figure 2 – Aerial View of Property.....	2
Figure 3 – Existing Site Features/Site Plan .....	3
Figure 4 – Existing Conditions.....	4
Figure 5 – Washoe County Zoning Map .....	5
Figure 6 – City of Sparks Zoning Map .....	6

### Appendices:

Washoe County Development Application  
Special Use Permit Application

### Attachments:

Septic System Documentation



## Introduction

This application includes the following request:

- A **Special Use Permit** to allow for the establishment of a 25-bed Group Care Facility (connected to city sewer) or 18-bed Group Care Facility (with existing septic system) use within the Low Density Suburban (LDS) zone.

## Project Location

The project site (APN # 026-442-14) includes 1.0± acres located at 1995 Ponderosa Drive in Washoe County. Specifically, the subject property is located on the south side of Ponderosa Drive, west of the intersection with Sullivan Lane. Figure 1 (below) depicts the project location.

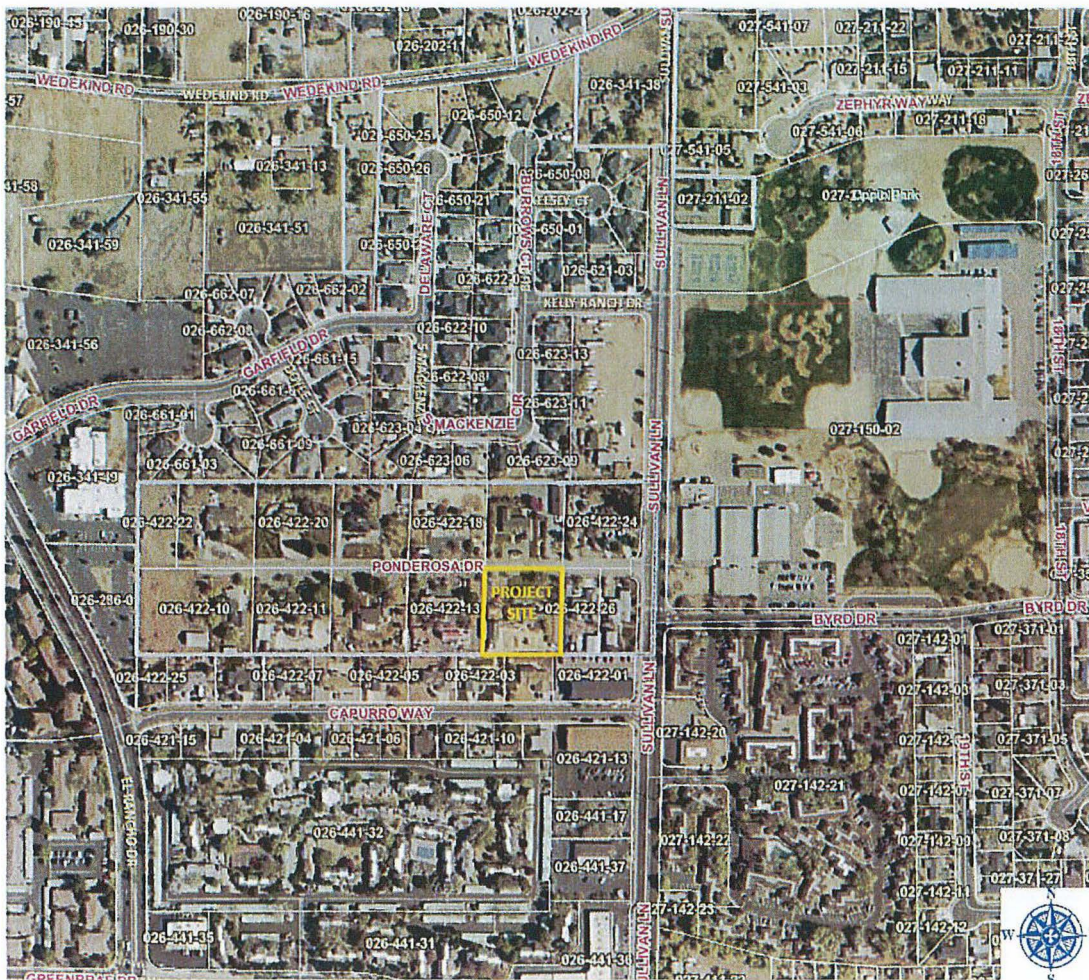

Figure 1 – Vicinity Map



### Existing Conditions

The site was originally developed as a single-family residence and includes an existing garage, outbuilding/office space and a 4 bedroom and bath dwelling addition.

Figure 2 (below) provides an aerial view of the property and existing structures while Figure 3 (page 3) includes a detailed aerial view of the site/site plan with existing site features labeled. Figure 4 (page 4) includes photographs of the existing onsite conditions.

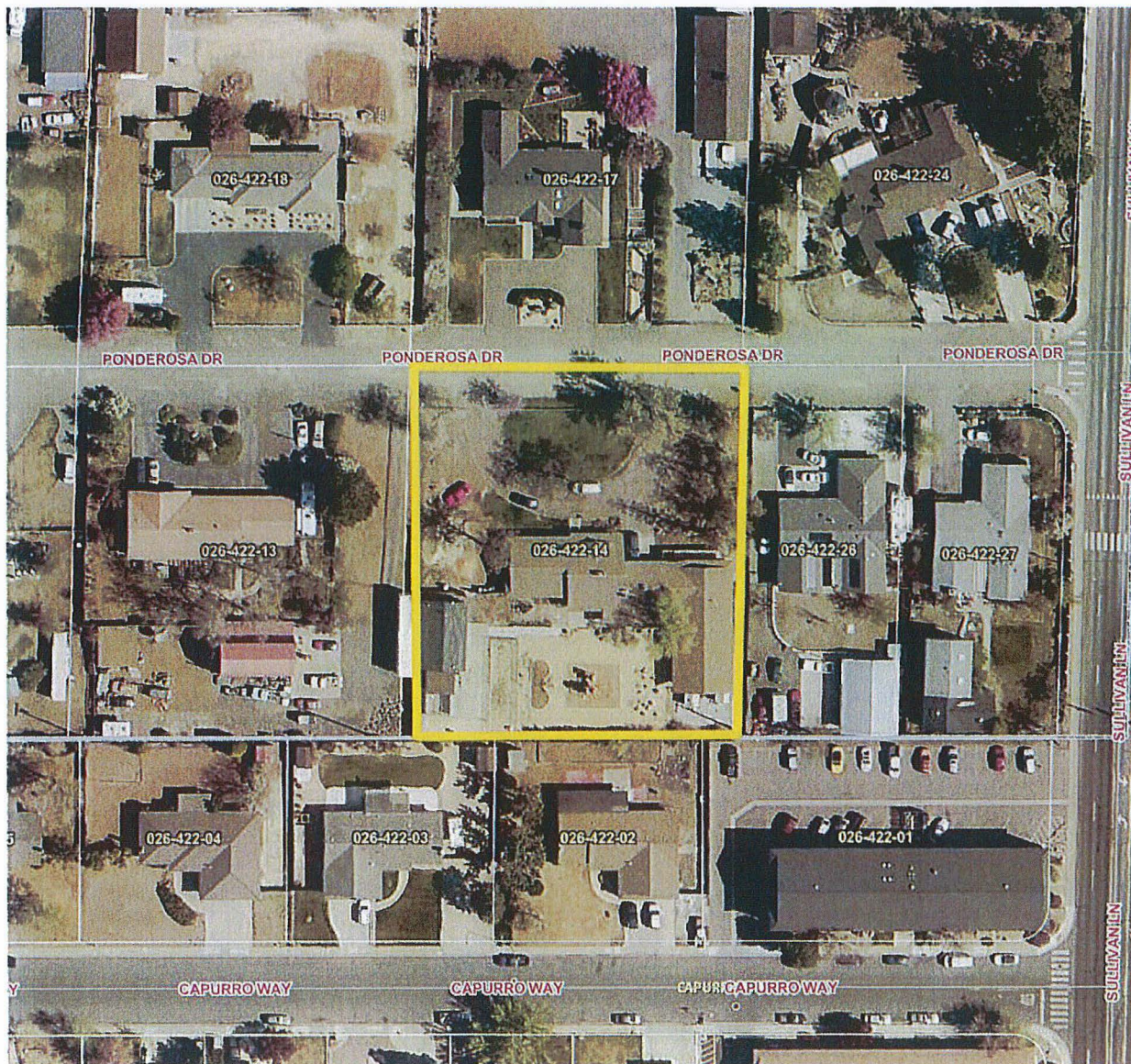

Figure 2 – Aerial View of Property





Figure 3 – Existing Site Features/Site Plan



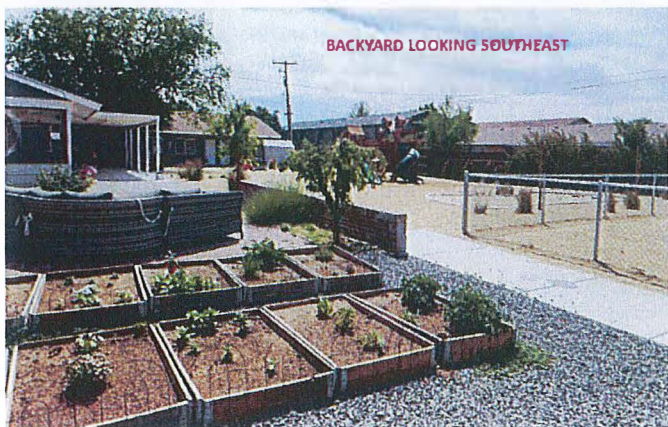
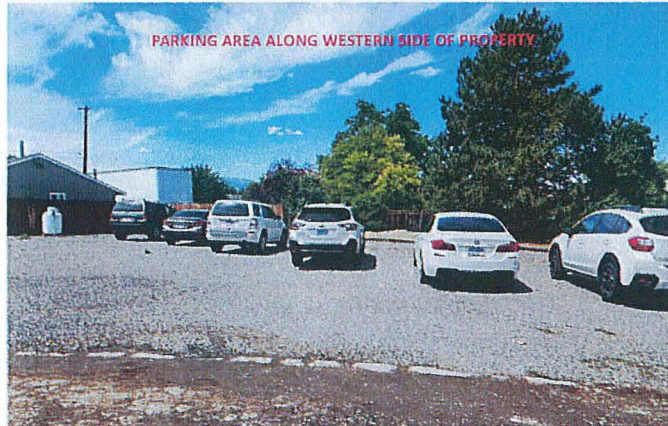
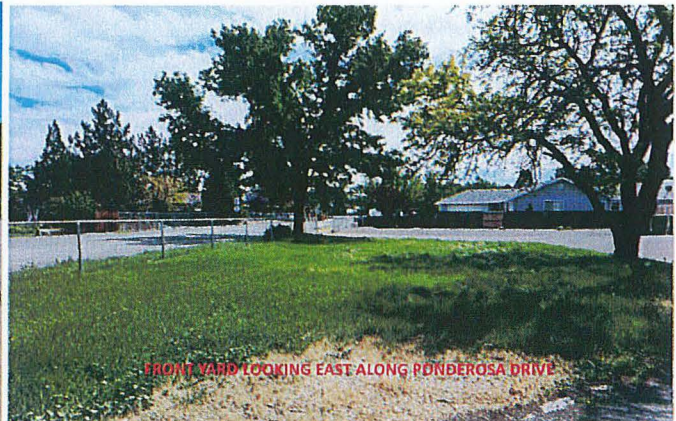
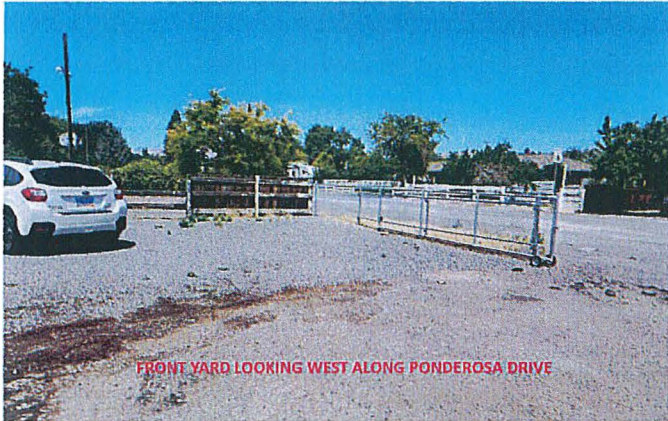

Figure 4 – Existing Conditions



Parcels that adjoin the site are single family residences similar to that of the project site. Property to the southwest has multi-family zoning with an office building along Sullivan Lane. With the exception of the properties adjacent to Ponderosa Drive within Washoe County, the surrounding properties (and those within the immediate vicinity) are located with the City of Sparks jurisdiction and are zoned Single Family 6, 9 and 15 (SF-6, SF-9 and SF-15), Multi-Family 4 and 5 (MF-4 and MF-5), Commercial (C2), Public Facilities (PF), and Professional Office (PO). General Rural (GR). Figures 5 (below) and 6 (page 6) provides the Washoe County and City of Sparks zoning maps.

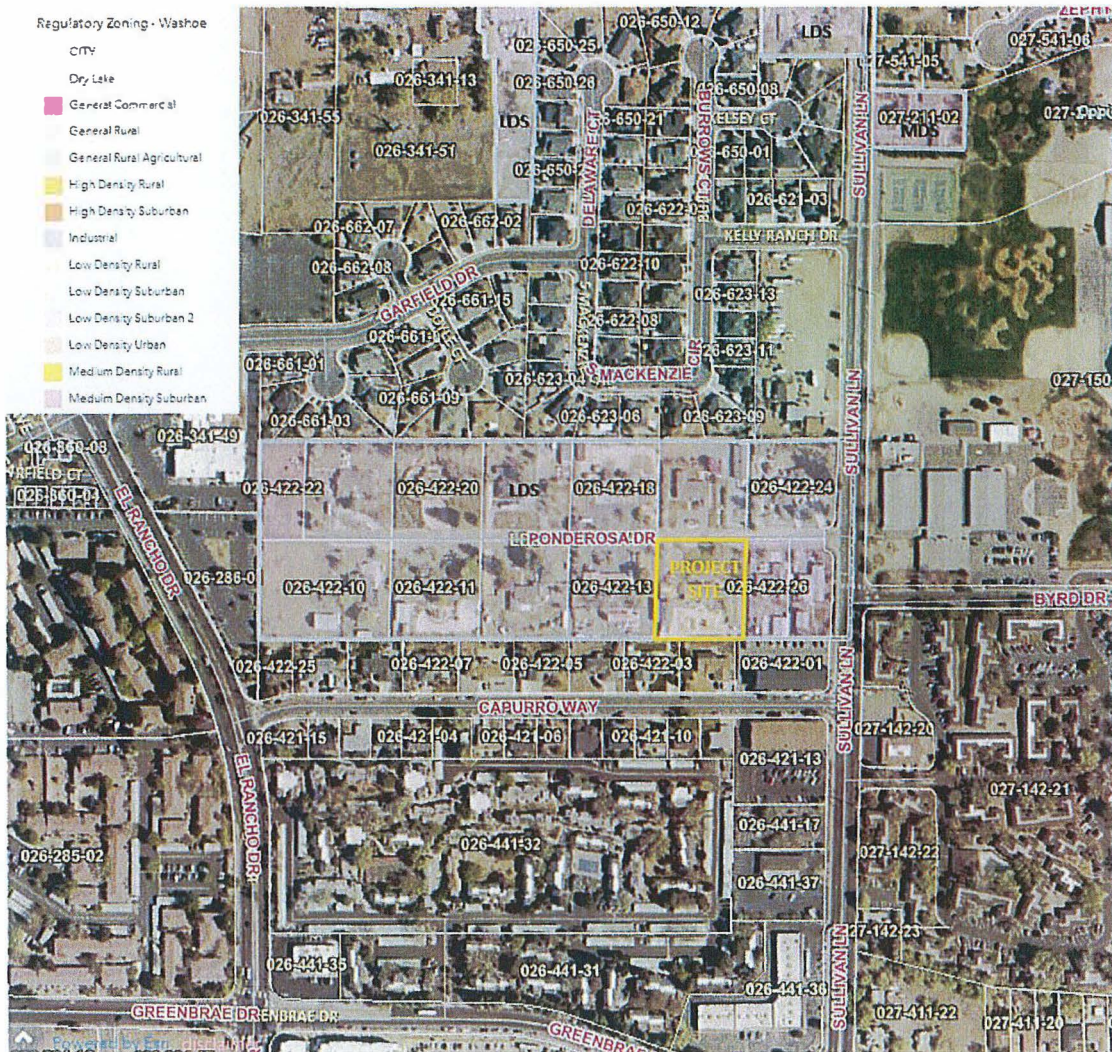

Figure 5 – Washoe County Zoning Map



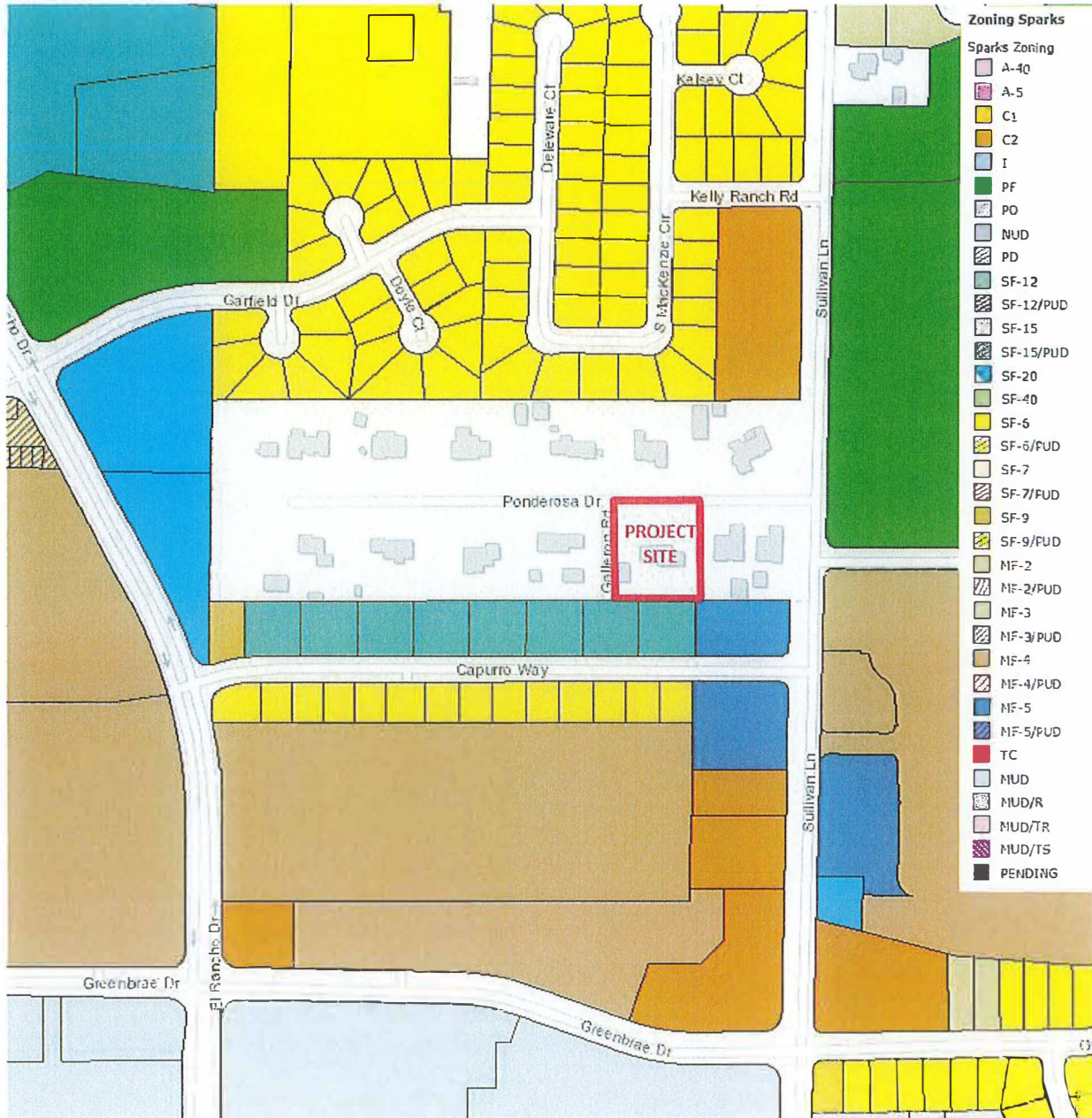

Figure 6 – City of Sparks Zoning Map



---

## Project Description/Request

This application includes an Amended Special Use Permit (SUP) request to establish a 25-bed Group Care Facility (connected to city sewer) or 18-bed Group Care Facility (with existing septic system) use within the Low Density Suburban (LDS) zone. An SUP application was previously submitted on August 8, 2022. During the review process, additional information was required regarding the septic system and the sizing of improvements performed upon the system in 2018. As a result, the project was temporarily put on hold while the construction and state documents were obtained. The research revealed that the septic field was sized for an 18-bed facility.

Currently, the applicant is in talks with the City of Sparks to connect the project site to municipal sewer, thus allowing the increase in permittable beds to 25 beds overall. We request that the 25-bed capacity be conditioned upon the connection to the City of Sparks municipal sewer.

If the connection cannot be established, the applicant is requesting 18 beds be allowed. The existing septic on site is sized for 18 beds after the upgrades in 2018. The Onsite Sewage Disposal System (OSDS) application and approval letter from NDEP are attached as an Attachment to this report.

Further discussions with Washoe County Staff and the City of Sparks resulted in the amended application for either a 25-bed group care facility if the property is connected to the City of Sparks sewer system or an 18-bed facility if the property remains on the existing permitted septic system.

As defined by the Washoe County Development Code, the SUP will allow for the operation of a maximum 25-bed group care facility. This use is specifically allowed in the Low Density Suburban (LDS) zone with the approval of a SUP per section 110.304.20 of the Development Code. Group care facilities must also comply with the review standards and guidelines in section 110.322.10 of the Development Code.

The Group Care Facility will provide 18 or 25 beds for temporary residents of the Care Facility. Residents include women, men and children and is inclusive to all. The length of stay of any individual is capped at 90 days. There are generally 4 staff members on site daily. In order to address the community concerns regarding safety and security, Safe Embrace is willing to hire an additional advocate to reside at the site during the overnight hours.

Safe Embrace is also upgrading the cameras and security system to allow for monitoring of the exterior of the residence. Additionally, as required in the development code guidelines, Safe Embrace is preparing a Neighborhood Response Program. This will provide a procedure for immediate response to incidents and complaints arising out of activities on site. This will include contact numbers and emails for the Executive Director and Shelter Manager and an email address for neighborhood residents to report neighborhood problems, suggestions and improvements to the group care facility.

The site has 4,100 square feet of living space. 25 beds/users require interior space of 4,050 square feet (1,200 sf for first 6 users plus 19 users x 150 sf/user = 4,050 square feet). Outdoor recreation space of 2,025 square feet is required for 25 users (600 sf for first 6 users plus 75 sf x 19 users = 2,025 sf). The site provides a 3,300 square foot outdoor recreation space at the rear of the property. If the site is allowed a maximum of 18 beds based upon the existing septic system size, the interior space required would be reduced to 3,000 square feet and the required outdoor recreation space would reduce to 1,500 square feet.

There is a pet shelter that can house 3 dogs and 6 cats/small animals. The dog pens include 3 dog runs with an indoor and outdoor run area. There have been nuisance complaints in the past regarding dogs barking at night. Since May of 2022, no pets have been allowed at the facility and a new pet policy is being prepared that will layout all rules and regulations and allow for removal of residents with pets for allowing dogs to bark and any neglect or nuisance complaints. The maximum number of animals allowed on site will adhere to the current Washoe County Code. Additionally, the outdoor portion of the dog run will not operate at night.

The property is a single-story building. The garage located on the subject property was converted to a living space in 2007. The setbacks are met for the property with the exception of the converted existing detached garage on the west property boundary. This building was converted in 2006 into work and office space. Additionally, the facility is required to meet all HUD requirements, is ADA compliant and has fire sprinklers throughout.

Parking is provided in a graveled parking area along the north end of the western property boundary and along the paved circular drive. This parking provides for the 10 required parking spaces (4 for employees and 6 for users). At this time, it is requested that the paving standard be waived for the site.

The existing landscaping on site will be supplemented to meet standards. Existing trees will be retained and additional landscaping along the road frontage will include one (1) tree for every fifty (50) linear feet of street frontage with additional bushes added between the trees. The adjacent residential property boundaries to the front of the buildings, including the parking area will include one (1) tree for every twenty (20) linear feet of the parking area, planted in off-set rows or groupings. It is requested that the existing 6-foot wood fences be allowed to remain.

No additional lighting is proposed for the site beyond what is already present. The property is not open to the public and the lighting is comparable to other properties on the street. At this time, it is requested that lighting the parking lot standard be waived to keep in character with the neighborhood.



---

## Special Use Permit Findings

In order to approve a Special Use Permit, the following findings must be made. Responses are provided in **bold face** type.

1. Consistency. The granting of the special use permit is consistent with the policies and maps of the Comprehensive Plan Elements and the Area Plan in which the property is located.

**The requested SUP is consistent with Washoe County Development Code and does not conflict with policies contained within the North Valleys Area Plan. The project is an existing operation and is appropriate for the area.**

2. Adequate Public Facilities. Adequate utilities, roadway improvements, sanitation, water supply, drainage, and other necessary facilities must exist or will be provided.

**The site is an existing facility with adequate utilities located on a private road.**

3. Site Suitability. The site must be physically suitable for the proposed use and for the intensity of development.

**The care facility has been in existence for over 20 years. The site was previously approved and operated under the City of Sparks before it was determined that the permitting should have been completed under Washoe County. This permit is to correct that inadvertent oversight for an operating site.**

4. Issuance Not Detrimental. Issuance of the permit may not be significantly detrimental to the public health, safety or welfare; have a detrimental impact on adjacent properties; or be detrimental to the character of the surrounding area.

**Safe Embrace provides a vital community service to those escaping domestic violence. The site location provides a discreet, safe, and appropriate location for Safe Embrace's services. The operational parameters described herein can be conditioned with the SUP ensuring that any and all potential impacts are properly mitigated. Concerns raised by surrounding neighbors at the two community meetings have been addressed with this SUP request and will be ongoing to ensure that negative impacts do not occur.**



# APPENDICES

## Washoe County Development Application

Your entire application is a public record. If you have a concern about releasing personal information, please contact Planning and Building staff at 775.328.6100.

<b>Project Information</b>		Staff Assigned Case No.: _____	
Project Name: <b>Safe Embrace SUP</b>			
Project Description: A Special Use Permit to allow for the establishment of a 25-bed Group Care Facility (connected to city sewer) or 18-bed Group Care Facility (with existing septic system) use within the Low Density Suburban (LDS) zone.			
Project Address: 1995 Ponderosa Drive, Sparks, NV 89431			
Project Area (acres or square feet): 1 acre			
Project Location (with point of reference to major cross streets <b>AND</b> area locator): 3 lots to the west from intersection of Ponderosa Drive and Sullivan Lane, on the south side of Ponderosa Drive.			
Assessor's Parcel No.(s):	Parcel Acreage:	Assessor's Parcel No.(s):	Parcel Acreage:
026-422-14	1.000		
Indicate any previous Washoe County approvals associated with this application: Case No.(s).			
<b>Applicant Information (attach additional sheets if necessary)</b>			
<b>Property Owner:</b>		<b>Professional Consultant:</b>	
Name: Safe Embrace		Name: Christy Corporation, LTD	
Address: 220 S Rock Blvd Ste 7		Address: 1000 Kiley Parkway	
Reno, NV	Zip: 89502	Sparks, NV	Zip: 89436
Phone: (775) 342-3766	Fax:	Phone: (775) 502-8552	Fax:
Email: afshan@safeembrace.org		Email: Lisa@christynv.com	
Cell: (775) 376-3457	Other:	Cell: (908) 763-6576	Other:
Contact Person: Afshan West		Contact Person: Lisa Nash	
<b>Applicant/Developer:</b>		<b>Other Persons to be Contacted:</b>	
Name: Same		Name:	
Address:		Address:	
	Zip:		Zip:
Phone:	Fax:	Phone:	Fax:
Email:		Email:	
Cell:	Other:	Cell:	Other:
Contact Person:		Contact Person:	
<b>For Office Use Only</b>			
Date Received:	Initial:	Planning Area:	
County Commission District:		Master Plan Designation(s):	
CAB(s):		Regulatory Zoning(s):	

# Special Use Permit Application Supplemental Information

(All required information may be separately attached)

1. What is the project being requested?

A Special Use Permit to allow for the establishment of a 25-bed Group Care Facility (connected to city sewer) or 18-bed Group Care Facility (with existing septic system ) use within the Low Density Suburban (LDS) zone.

2. Provide a site plan with all existing and proposed structures (e.g. new structures, roadway improvements, utilities, sanitation, water supply, drainage, parking, signs, etc.)

See attached report.

3. What is the intended phasing schedule for the construction and completion of the project?

No phasing.

4. What physical characteristics of your location and/or premises are especially suited to deal with the impacts and the intensity of your proposed use?

This use has been in existence for over 20 years and the site is appropriate to the use.

5. What are the anticipated beneficial aspects or affects your project will have on adjacent properties and the community?

The project is a very necessary and vital service to the community.

6. What are the anticipated negative impacts or affect your project will have on adjacent properties? How will you mitigate these impacts?

The installation of additional landscaping and appropriate screening materials for the property will occur to ensure applicable codes are met. The is detailed in the attached report.

7. Provide specific information on landscaping, parking, type of signs and lighting, and all other code requirements pertinent to the type of use being purposed. Show and indicate these requirements on submitted drawings with the application.

Refer to the attached report for this information.

8. Are there any restrictive covenants, recorded conditions, or deed restrictions (CC&Rs) that apply to the area subject to the special use permit request? (If so, please attach a copy.)

<input type="checkbox"/> Yes	<input checked="" type="checkbox"/> No
------------------------------	--

9. Utilities:

a. Sewer Service	Septic or Future City Sewer Connection
b. Electrical Service	NV Energy
c. Telephone Service	Various Providers
d. LPG or Natural Gas Service	NV Energy
e. Solid Waste Disposal Service	Waste Management
f. Cable Television Service	Various Providers
g. Water Service	TMWA

For most uses, Washoe County Code, Chapter 110, Article 422, Water and Sewer Resource Requirements, requires the dedication of water rights to Washoe County. Please indicate the type and quantity of water rights you have available should dedication be required.

h. Permit #		acre-feet per year	
i. Certificate #		acre-feet per year	
j. Surface Claim #		acre-feet per year	
k. Other #		acre-feet per year	

Title of those rights (as filed with the State Engineer in the Division of Water Resources of the Department of Conservation and Natural Resources).

10. Community Services (provided and nearest facility):

a. Fire Station	TMFPD
b. Health Care Facility	Renown
c. Elementary School	Risley
d. Middle School	Sparks Middle School
e. High School	Hug High School
f. Parks	Washoe County Parks
g. Library	Sparks Library
h. Citifare Bus Stop	Greenbrae and Sullivan

# ATTACHMENTS



Nevada Division of Environmental Protection
Bureau of Water Pollution Control

ENTERED
3/16/18
[Signature]

Onsite Sewage Disposal System (OSDS) Application RECEIVED

General Permit No. GNEVOSDS09

FEB 28 2018

Note: Please consult with local or state agency to confirm the proposed method of sewage disposal at your location is acceptable; some restrictions may apply. Please refer to NRS 445A & NAC 445A.

APPLICANT: (Agency/Person responsible for the OSDS System)

Name: John Etchmendy Phone:
Address: 1995 Ponderosa Drive Fax:
City: Sparks State: Nevada Zip: 89506

SITE LOCATION(S): If more than one, please attach a legal description of each site.

Project Name Safe Embrace Addition
Project Address: 1995 Ponderosa Drive
City: Sparks County: Washoe State NV Zip: 89506
Latitude: N 39 / 33 / 0.44 Longitude: W 119 / 46 / 20.89
Deg. Min. Sec. Deg. Min. Sec.
Township 20 Range 20 Section 31

ENGINEERING FIRM INFORMATION

Name: Pezonella Associates, Inc Phone: (775) 856-5566 Fax (775) 856-6042
Contact Person: Ray Pezonella email: ray@pezonella.com
Address: 520 Edison Way
City: Reno State: Nevada Zip: 89502

**THE FOLLOWING INFORMATION MUST BE INCLUDED WITH THE APPLICATION:**

**GENERAL SITE INFORMATION:**

- Business Description (church, school etc.): Group Home Care Facility
- Assessor's Parcel Number (APN): 026-42214
- Property Area (in acres): 1.006
- Distance to Public Sewer (if any): Over 200 feet
- Water Supply (city or well): City Well: Depth: \_\_\_\_\_ (ft) Seal (if any) \_\_\_\_\_ (ft)
- Is proposed location within 100 year or 50 year flood zone?: No

**OSDS INFORMATION:**

- Number of proposed OSDS Tanks: 1
- Size of Proposed OSDS System(s): 4,000 (gallons)
- Tank Model(s): Jensen Ty 4000 Distribution Box Model(s): Jensen D30
- Is this a denitrifying, mechanical or aerobic OSDS System No
- Existing OSDS Systems (if any): Total Tanks 1 Total Volume: 1,000 (gallons)
- NDEP Permit (if any) : WCDHD
- Total volume of OSDS systems in this property : 4,000 (gallons)

**SITE PLAN:**

- Site plan drawn to scale – 2 sets needed
- Setbacks shown and in accordance with NAC 445A
- Location of test pits within proposed absorption area
- Please verify that OSDS system will only treat Domestic sewage.

**OSDS CALCULATIONS:**

- Calculations Submitted
- OSDS Size based on Occupational Flow: 18 person Group home & 8 Fixture Unit Computer Lab
- \_\_\_\_\_ OSDS Size based on Fixture Unit Count: \_\_\_\_\_



x   Percolation rate/absorption rate: \_\_\_\_\_ (min/in) – Design rate/absorption rate:   15   (min/in)

  x   Depth to Seasonal High Groundwater:   N/a   (ft)

  x   Type of absorption system (trenches, chambers mound etc):   Absorption bed  

  x   Total OSDS Absorption area:   4,896   (ft<sup>2</sup>)

  x   Total Absorption trench length:   n/a   (ft)

  x   Number and length of trenches:   n/a   Trench Separation \_\_\_\_\_

  x   Dosing Tank information – (if required):   412 gallons per dose  

\_\_\_\_\_

\_\_\_\_\_

**CERTIFICATION:**

"I certify under penalty of law that this document and all attachments were prepared under my direction or supervision in accordance with a holding tank designed to assure that it complies with Nevada Division of Environmental Protection regulations. I also confirm that records will be maintained at the project site from the start of activities, and that the site will be compliant. Based on my inquiry of the person or persons who manage the system, or those persons directly responsible for gathering the information, the information submitted is, to the best of my knowledge and belief, true, accurate, and complete. I am aware that there are significant penalties for submitting false information, including the possibility of fines for knowing violations."

Printed Name of Applicant (Owner/Operator):   Ray Pezonella  

Signature:      Date:   2/28/15  

A copy of the permit will be mailed to you along with your discharge authorization.

Send completed form to:

OSDS Program Coordinator  
 Nevada Division of Environmental Protection  
 Bureau of Water Pollution Control  
 901 S. Stewart Street, Suite 4001  
 Carson City, Nevada 89701-5249

SEWAGE DISPOSAL SYSTEM  
 SAFE EMBRACE ADDITION  
 1995 PONDEROSA DRIVE  
 SPARKS, NEVADA



Consulting Engineers  
 520 Edison Way Reno, Nevada 89502  
 PHONE (775) 656-5566 FAX (775) 656-6012

**Pezomella, Inc.**

DATE	1/20/18
BY	DBB/BJL
CHECKED	DBB/BJL
DATE	JAN 30, 2018
PROJECT	C1

SITE PLAN PROVIDED BY  
 FRAME ARCHITECTURE

PONDEROSA DRIVE

REPAIR SYSTEM  
 51 FT. x 12 FT. PERFORATED PIPE  
 WITH TEN LINES 30 FT. LONG OF 4" PERFORATED PIPE

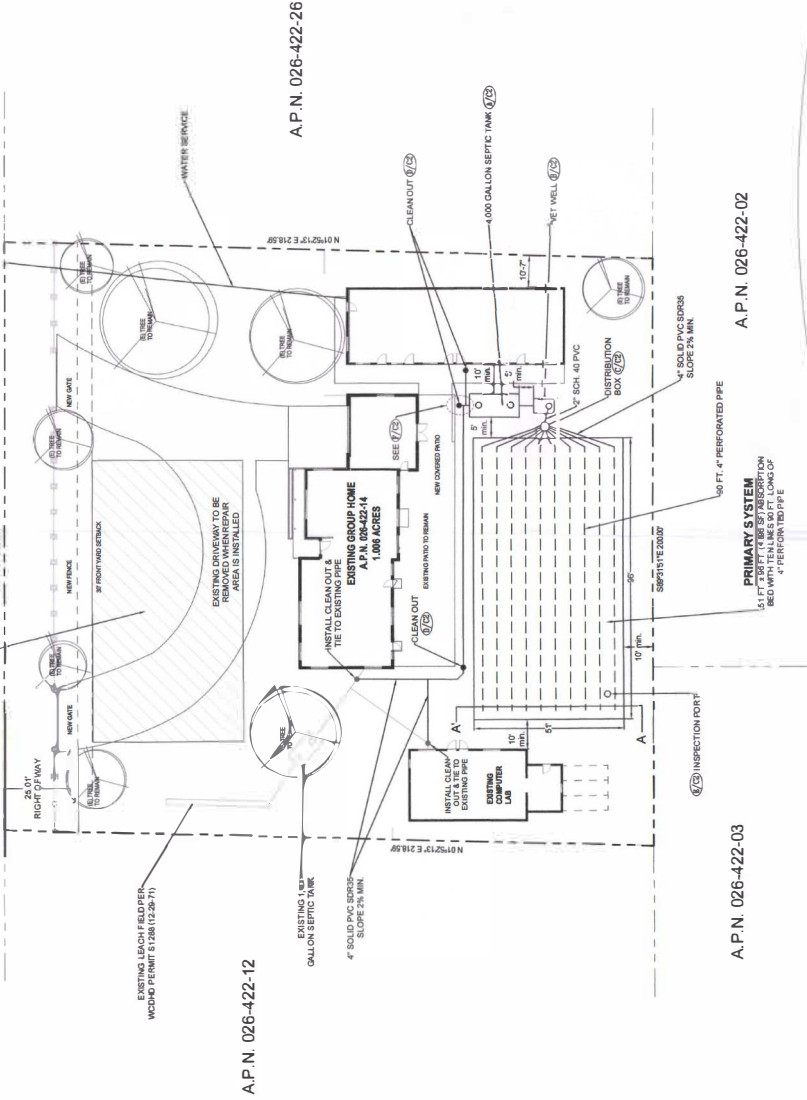

A.P.N. 026-422-26

A.P.N. 026-422-02

A.P.N. 026-422-12

A.P.N. 026-422-03

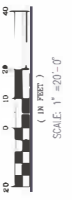

**NOTES:**

1. THE EXISTING GROUP HOME AND COMPUTER LAB ARE TO REMAIN CONNECTED TO THE EXISTING 1,000 GALLON SEPTIC TANK. THE EXISTING SEPTIC TANK AND ASSOCIATED SYSTEMS ARE TO BE COMPLETED AND APPROVED.
2. ONCE THE NEW SYSTEM IS APPROVED THE EXISTING GROUP HOME AND COMPUTER LAB ARE TO BE RECONNECTED TO THE EXISTING SEPTIC TANKS. THE EXISTING SEPTIC TANKS ARE TO BE PUMPED OUT AND THEN MANHOLED IN PLACE.

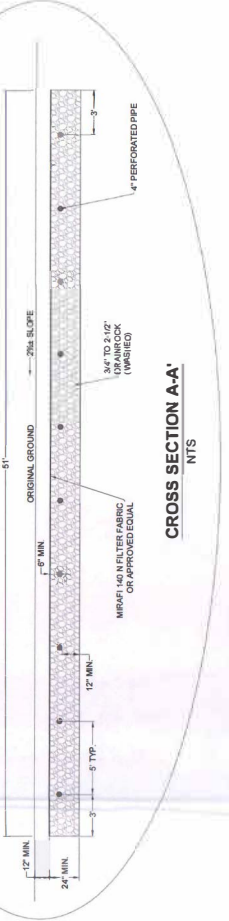

**WSUP22-0019  
 EXHIBIT F**

### 4000 GALLON COMMERCIAL SEPTIC TANK OR APPROVED EQUAL

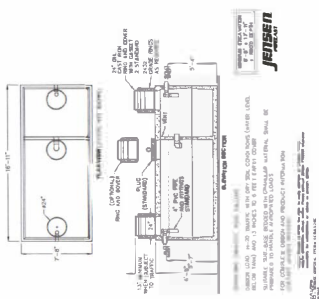

### SEPTIC TANK (A/C2)

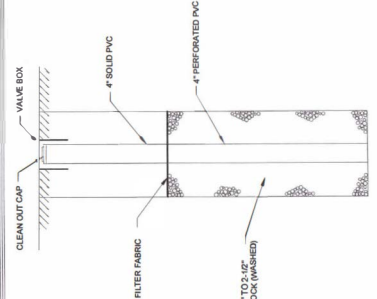

### INSPECTION PORT (E/C2)

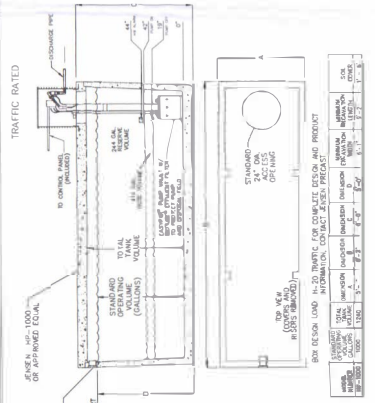

### WET WELL

### COMMERCIAL DISTRIBUTION BOX OR APPROVED EQUAL

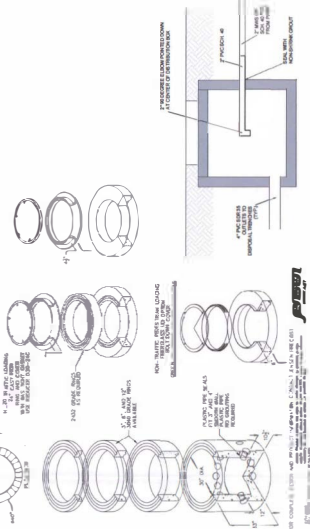

### DISTRIBUTION BOX (C/C2)

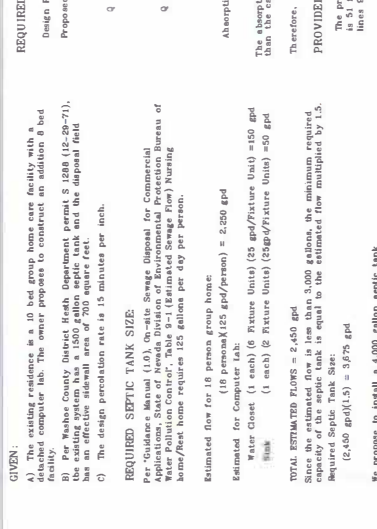

### CLEAN OUT (D/C2)

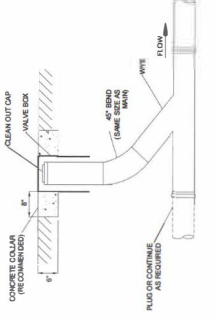

**DOSING CYCLE:**  
 $V = (\pi)(R)(L)(0.70)$   
 where:  
 R = Radius of pipe (2' for 4" pipe)  
 L = Length of perforated pipe (800 ft)  
 V = 70% of the volume of the perforated pipe  
 $82.4 \text{ ft}^3 \times \text{Weight of water per cubic foot}$   
 $82.4 \text{ ft}^3 \times 6.24 \text{ Pound per gallon of water}$   
 $(3.14)(2 \text{ ft})(800 \text{ ft})(0.70) = 54.95 \text{ ft}^3$   
 $(54.95 \text{ ft}^3)(6.24 \text{ gpc}) = 412 \text{ gallons}$   
 The residence is 412 gallons.

### NOTES

- NO COMMUNITY SEWER AVAILABLE WITHIN 200' OF THE PROPERTY.
- BASED ON COMMUNITY PARCEL NO. 3861(C)056, PREPARED BY THE FEDERAL BUREAU OF SURVEY AND MAPPING, 1995. THE PROPERTY IS UNINSURED AND OUTSIDE THE AREAS OF 0.2% ANNUAL CHANCE OF FLOODS (100 YEAR FLOOD).
- NO PUBLIC WELL WITHIN 200 FEET OF THE PROPERTY.
- DRAINAGE AROUND BUILDING SHALL COMPLY WITH APPLICABLE BUILDING CODES.
- THE BUILDING SEWER AND SOLID LINE BETWEEN THE SEPTIC TANK AND DISPOSAL TANK SHALL BE ON A SLOPE NOT LESS THAN ONE-FORTY (1/40) INCH PER FOOT (2%).
- PREPARED DISTRIBUTION LINES SHOULD BE LEVEL, THE BOTTOM OF THE DISPOSAL BED SHALL BE ESSENTIALLY LEVEL.
- THIS SYSTEM IS DESIGNED TO TREAT ONLY "DOMESTIC SEWAGE", WHICH IS ANY LIQUID AND WATERBORNE WASTE THAT IS DERIVED FROM THE ORDINARY LIVING PROCESS AND IS OF SUCH CHARACTER AS TO PERMIT ITS SATISFACTORY DISPOSAL TO THE SOIL. THIS SYSTEM IS NOT DESIGNED TO TREAT INDUSTRIAL OR HAZARDOUS WASTE.
- SEPTIC SYSTEM MAINTENANCE IS RECOMMENDED. VISIT THE EPA WEBSITE AT <http://efpub.epa.gov/ewm/epw12/homeww.asp> FOR MAINTENANCE PROCEDURES.

### NOTES

### CALCULATIONS

**LEGAL OWNER:**  
 SAFE EMBRACE DRIVE  
 1995 PONDEROSA DRIVE  
 SPARKS, NEVADA

**ENGINEER:**  
 PEZONELLA ASSOCIATES, INC.  
 520 EDISON WAY  
 RENO, NEVADA  
 (775) 658-5566

**VICINITY MAP**  
 EL RANCHO DR.  
 PONDEROSA DR.  
 N NVADITAS  
 GREENBRAE DR.  
 ODDIE BLVD.

### VICINITY MAP

SEWAGE DISPOSAL SYSTEM- DETAILS  
 SAFE EMBRACE ADDITION  
 1995 PONDEROSA DRIVE  
 SPARKS, NEVADA

2/27/18  
 Septic Design Only

PEZONELLA ASSOCIATES, INC.  
 Consulting Engineers  
 520 Edison Way Reno, Nevada 89502  
 PHONE (775) 656-5566 FAX (775) 658-6042

PROJECT NO. 2017-18  
 SHEET NO. 53B-02-M  
 DATE: FEB. 13, 2018  
 MTS