



Geotechnical & Environmental Services, Inc.
Las Vegas | Reno | Mesquite

**GEOTECHNICAL EVALUATION
6400 CHOCOLATE DRIVE
MULTI-FAMILY RESIDENCES
SUN VALLEY, NEVADA**

**PROJECT NO. R20215772E1
January 13, 2022**



Prepared for:



770 3rd Avenue, S.W.
Carmel, IN 46032, US



January 13, 2022
Project No. R20215772E1

Mr. Colin Patterson, PE
Pedcor Investments
770 3rd Avenue, SW
Carmel, Indiana 46032

**GEOTECHNICAL &
ENVIRONMENTAL
SERVICES, INC.**

**RE: Geotechnical Evaluation
6400 Chocolate Drive
Multi-Family Residences
Sun Valley, Nevada**

• Geotechnical
Engineering

• Construction
Materials
Testing &
Inspections

• Environmental
Services

• AASHTO
Accredited
Testing
Laboratories

• IAS
Accredited

Dear Mr. Patterson:

Geotechnical & Environmental Services, Inc. (GES) is pleased to present the Geotechnical Evaluation report for the proposed multi-family residences located at 6400 Chocolate Drive in Sun Valley, Nevada.

The content of this report encompasses the findings of the geologic review, the results of the field exploration and laboratory testing programs, conclusions, and recommendations for the site development.

We appreciate this opportunity to provide our professional services. If you have any questions or comments regarding this information, please feel free to contact our office.

Sincerely,

Geotechnical & Environmental Services, Inc.

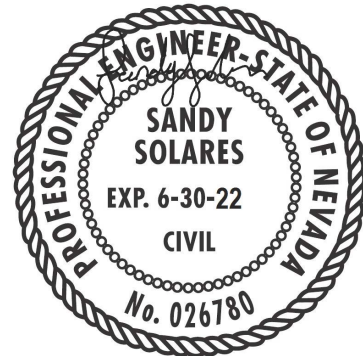

Ty Miller, E.I.
Staff Engineer

TM:SS:sb

Dist: PDF e-mailed to addressee at copatterson@pedcor.net
PDF saved to Project File

Sandy Solares, P.E.
Project Engineer

Las Vegas
7150 Placid Street
Las Vegas, NV 89119 •
702.365.1001

Reno
5301 Longley Lane, Bldg. H, Suite 116
Reno, NV 89511 • 775.622.3844

Mesquite
530 Commerce Circle
Mesquite, NV 89027 •
702.346.4489

We make the ground work for you...®

www.gesnevada.com

TABLE OF CONTENTS

1. INTRODUCTION	3
1.1. PURPOSE AND RESOURCES	3
1.2. PROJECT DESCRIPTION	3
1.3. SITE DESCRIPTION	4
2. GEOTECHNICAL SITE CHARACTERIZATION	5
2.1. GEOLOGY	5
2.2. SEISMICITY	5
2.3. LIQUEFACTION	6
2.4. GROUNDWATER	6
2.5. FIELD EXPLORATION	7
2.6. LABORATORY TESTING	8
2.7. SUBSURFACE MATERIALS AND CONDITIONS	9
2.7.1. FILL	9
2.7.2. NATIVE SOIL	9
3. FINDINGS	10
4. RECOMMENDATIONS	11
4.1. EARTHWORK	11
4.1.1. SITE PREPARATION	11
4.1.2. STRUCTURAL FILL AND BACKFILL SUITABILITY	12
4.1.3. FILL PLACEMENT	13
4.1.4. OBSERVATION AND TESTING	13
4.2. EXCAVATION CONSIDERATIONS	14
4.2.1. TEMPORARY EXCAVATIONS	14
4.3. UNDERGROUND UTILITIES	14
4.4. FOUNDATIONS	15
4.4.1. SHALLOW FOUNDATIONS	15
4.4.2. CONVENTIONALLY REINFORCED SLABS-ON-GRADE	16
4.4.3. POST-TENSIONED SLABS-ON-GRADE	17
4.5. SEISMIC SITE CLASS	17
4.6. LATERAL EARTH PRESSURES ON RETAINING WALLS	19
4.7. EXTERIOR CONCRETE FLATWORK CONSTRUCTION	20
4.8. MINIMUM RECOMMENDED ASPHALT PAVEMENT SECTIONS	20
4.9. MINIMUM RECOMMENDED RIGID PAVEMENT SECTIONS	21
4.10. SOIL CORROSIVITY	22
4.11. DRAINAGE AND MOISTURE PROTECTION	22
4.12. PRE-CONSTRUCTION MEETING	23
4.13. CONTINUITY	23
5. LIMITATIONS	24
6. REFERENCES	25

TABLES

Table 2.5-1 Field Exploration Summary 8
Table 4.1.1-1 Recommended Minimum Overexcavation Depths/ Fill Blanket Thickness 12
Table 4.1.2-1 Imported and/or On-site Structural Fill Recommendations..... 13
Table 4.5-1 Spectral Response Accelerations and Site Coefficients – Site Class C 18
Table 4.8-1 Recommended Minimum Asphalt Concrete Pavement Sections..... 20
Table 4.9-1 Recommended Minimum Rigid Pavement Sections 21
Table 4.10-1 Concrete Recommendations for Severe Sulfate Exposure..... 22

FIGURES

Figure 1.3-1 Project Site 4
Figure 2.1-1 Geologic Site Map 5
Figure 2.2-1 Approximate Fault Location 5
Figure 2.5-1 Test Pit Locations 7
Figure 2.7.2 Native Matieral from TP-6 9
Figure 4.5-1 ReMi Field Test Results..... 18

APPENDICES

- APPENDIX A – SUBSUFACE STUDY
- APPENDIX B – LABORATORY TEST RESULTS
- APPENDIX C – DESIGN FIGURES

EXECUTIVE SUMMARY
6400 CHOCOLATE DRIVE
MULTI-FAMILY RESIDENCES
SUN VALLEY, NEVADA

This Executive Summary is for reference only and is not fully comprehensive of the findings and recommendations specified in this Geotechnical Evaluation. Select the topics and underlined subjects to go to the appropriate section of the report. GES will not be held responsible for interpretations made by others based solely on the information presented in the Executive Summary. We encourage a full reading and a clear understanding of the conclusions and recommendations presented in the full report.

Topic	Overview
Project Description	<ul style="list-style-type: none"> • 20 two-story multi-family residential buildings and a clubhouse, covered parking areas, swimming pool, playground, and other minor recreational facilities. • Assumed downward axial column loads of up to approximately 50 kips and wall loads of up to 3 kips per lineal foot. • Final design grades are anticipated to generally be within 5 feet of existing site grades.
Geotechnical Site Characterization	<ul style="list-style-type: none"> • Up to 8 feet of fill material was encountered towards the north end of the project site. • Native soils consist of clay, silt, and sand with varying amounts of and gravel underlain by bedrock consisting of decomposed andesite. • <u>Groundwater</u> was not encountered in our test pits. • <u>Liquefaction potential</u> is low. • <u>Seismic site class: C</u>
Earthwork	<ul style="list-style-type: none"> • Excavate existing uncontrolled fill, deleterious material, loose or disturbed native soils from improvement areas. • Continuous grading observation is recommended. • Overexcavate beneath structures and site improvements. • Import fill and on-site soils may be suitable for <u>structural backfill</u>.
Shallow Foundations	<ul style="list-style-type: none"> • Shallow foundations (spread and continuous) are acceptable • Ultimate allowable bearing pressure = 3,000 psf • Expected settlement <1-inch

Topic	Overview
Concrete Flatwork	<ul style="list-style-type: none"> • 4-inch minimum concrete thickness with 4-inch minimum aggregate base thickness. • Concrete should have a design compressive strength of 2,500 psi and water-cement ratio of 0.50.
Recommended Asphalt Pavement Sections	<p>For an R-Value of 5:</p> <ul style="list-style-type: none"> • Parking Areas – 4" AC over 8" Type 2 class B • Driveways – 4" AC over 12" Type 2 Class B
Recommended Rigid Pavement Sections	<p>For an R-Value of 5</p> <ul style="list-style-type: none"> • Parking Areas – 4" PCC over 4" Type 2 class B • Driveways – 4.5" PCC over 4" Type 2 class B

GEOTECHNICAL EVALUATION
6400 CHOCOLATE DRIVE
MULTI-FAMILY RESIDENCES
SUN VALLEY, NEVADA

1. INTRODUCTION

This report presents the results of a geotechnical study performed by Geotechnical & Environmental Services, Inc. (GES) for the proposed multi-family residential development located at 6400 Chocolate Drive in Sun Valley, Nevada. Figure A-1 presents a vicinity map showing the approximate location of the site within Sun Valley, Nevada. Figure A-2 presents the exploration location map within the project site, as shown on the figure, our explorations were completed within the 45.5-acre project boundary. Based on the native surface conditions, the geology within the project area, and our findings of the subsurface conditions, it is opinion that our recommendations are applicable for the 6400 Chocolate drive multi-family residential development. The following sections present the purpose and scope of our geotechnical exploration, project and site descriptions, field exploration, and laboratory testing.

1.1. PURPOSE AND RESOURCES

The purposes of our geotechnical study were to evaluate subsurface soils within the proposed project site and provide a design level geotechnical evaluation to aid in the design and construction of the proposed project improvements. The scope of this study included a review of referenced geologic literature and maps, subsurface exploration, soil sampling, laboratory testing of selected soil samples, engineering evaluations, and preparation of this report. The scope of work contained herein is provided in general accordance with our proposal, dated September 17, 2021.

1.2. PROJECT DESCRIPTION

Our understanding of the project is based on correspondence with the client, a review of aerial photographs and documents, and our experience with similar projects. Our design recommendations are based on the 2018 International Building Code (IBC). We understand that the proposed project will include design and construction of a multi-family residential development located on approximately 45.5 acres in Washoe County, Nevada. The development is anticipated to include 20 two-story buildings, a clubhouse and swimming pool, 240 covered parking spaces, mail kiosks, playground, and other minor recreational amenities. We assume downward axial column loads for the buildings to be up to approximately 50 kips and wall loads of up to 3 kips per lineal foot. Below grade structures are not anticipated. Other improvements are anticipated to consist of asphalt

and concrete pavement parking areas, concrete curbs and gutters, sidewalks, and underground utilities. We anticipate that final design grades will generally be within 5 feet of existing site grades.

1.3. SITE DESCRIPTION

The project site consists of approximately 45.5-acres of land and is currently vacant and undeveloped, consisting of hills and valleys covered by native desert. The site is bordered by vacant properties to the west and south as well as residences to the east and north. The project site is bordered Red Hill to the west, West 5th Avenue to the north, Chocolate Drive and private residences to the east and West 2nd Avenue to the south.

Figure 1.3-1 Project Site



2. GEOTECHNICAL SITE CHARACTERIZATION

The following sections describe the geology, seismicity, liquefaction, mapped soil conditions, field exploration, laboratory testing, and subsurface materials and conditions for the project site.

2.1. GEOLOGY

The subject site is located on the referenced, Preliminary Revised Geologic Maps of the Reno Urban Area, Nevada (Ramelli, A.R., 2011). Most of the site, including most of the proposed building locations, will be in the undivided pre donner lake age deposits. Other formations either nearby or partially included in the development are granite rock of Peavine Mountain, andesite lava of Peavine Mountain, and quartz-alunite ledge.



Figure 2.1-1 Geologic Site Map

2.2. SEISMICITY

Based on a review of the USGS Quaternary Fault Database, accessed on December 27, 2021, the site lies near many undifferentiated Quaternary (1.6 million year) faults. The closest, Spanish Springs Valley fault, runs on the west side of the property, possibly through the property. The fault dips to the east and slips at a rate less than 0.2 mm per year. The approximate location of the Spanish Springs Valley Fault is shown using the USGS Quaternary Faults website in Figure 2.2-1.

The Nevada Earthquake Safety Counsel and standard practice advise against building within 5-feet of a known active Quaternary fault. Knowing the proximity of the proposed buildings to the fault, some building locations



Figure 2.2-1 Approximate Fault Location

may have to be adjusted. During excavation of the property an experienced geologist should be present to identify and mark evidence of faults and fissures to physically locate the Spanish Springs Valley fault.

Based on the results of our review of available literature, it is our opinion that the potential for fault-related surface rupture at the site is low.

2.3. LIQUEFACTION

Liquefaction is a phenomenon in which loose, saturated soils lose shear strength under short-term (dynamic) loading conditions. Ground shaking of sufficient duration results in the loss of grain-to-grain contact in potentially liquefiable soils due to a rapid increase in pore water pressure causing the soil to behave as a fluid for a short period of time.

To be potentially liquefiable, a soil is typically cohesionless with a grain-size distribution generally consisting of sand and silt. It is generally loose to medium dense and has a relatively high moisture content, which is typical near or below groundwater level. The potential for liquefaction decreases with increasing clay and gravel content but increases as the ground acceleration and duration of shaking increase. Potentially liquefiable soils need to be subjected to sufficient magnitude and duration of ground shaking for liquefaction to occur.

Effects of liquefaction include relatively large total and differential settlements, flotation of subsurface structures, slope failures, lateral ground displacements (lateral spreading), surface subsidence, ground cracking, and sand boils.

The site soil samples taken and tested at this site were composed of sandy fat clay and silty sand with gravel. Our test pits and nearby water levels show water levels below 20-feet. With this information it is our determination that the potential for liquefaction is low.

2.4. GROUNDWATER

Groundwater was not encountered in the test pits to the depths explored. A review of historical water wells listed on the State of Nevada Department of Conservation and Natural Resources, Division of Water Resources website indicates that historical static groundwater levels in the vicinity of the site were measured in the 1950's at an elevation approximately ranging between 26 feet to 73 feet below the ground surface (Well logs 1348 and 38341, respectively).

Groundwater levels should be anticipated to fluctuate due to seasonal precipitation, groundwater withdrawal and recharge, irrigation practices, and potential future dewatering efforts within and/or near the subject site. A detailed evaluation of possible groundwater fluctuations is beyond the scope of this study. Based on the historical depth to groundwater it is not anticipated that groundwater will present a constructability challenge.

2.5. FIELD EXPLORATION

GES evaluated the subsurface conditions within the vicinity of the project site, by excavating 8 test pits (TP-1 through TP-8) on November 15-16, 2021, to a depth of approximately 20-feet below existing surface. The total depth excavated was approximately 153 vertical feet. Figure 2.5-1 and Figure A-2, in Appendix A of this report, shows the approximate test pit locations within the project area. The test pit coordinates (datum NAD 1983 HARN) were recorded by GES staff using a handheld GPS unit and approximate surface elevation estimated from Google Earth. Coordinates and elevations are provided on the exploration logs included in Appendix A.

The test pits were excavated with a track-mounted CAT-321 D LCR, using a 36-inch bucket width. Bulk samples were obtained from most test pits. The test pits were backfilled with soil cuttings and compacted by rolling the excavator over the backfilled material.

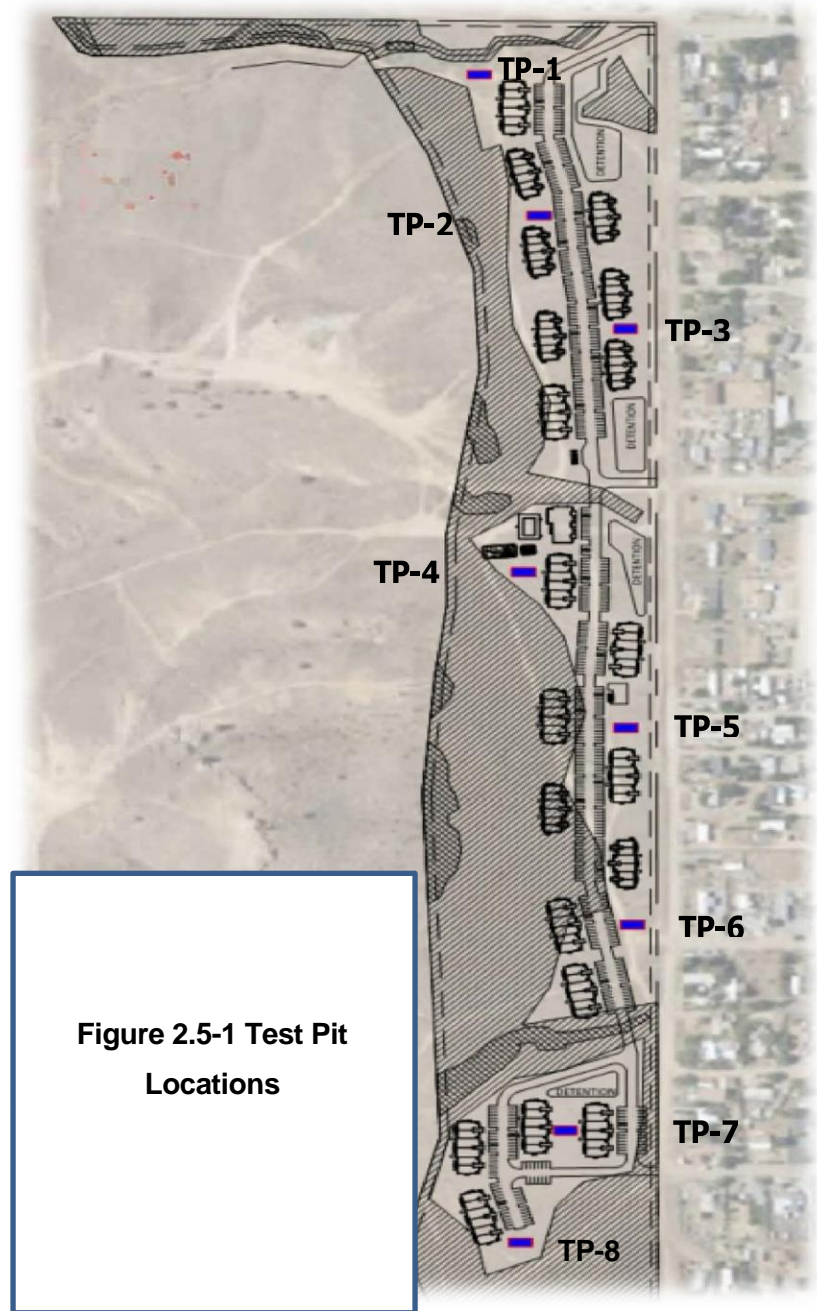

Table 2.5-1 Field Exploration Summary

Exploration ID	Depth (ft)	Latitude	Longitude	Ground Elevation (ft)	Equipment	Exploration Size / Type
TP-1	20	39.5921357	-119.7895115	4801	CAT-321 D LCR	Test Pit 12x3x20'
TP-2	20	39.5910924	-119.7901130	4807	CAT-321 D LCR	Test Pit 12x3x20'
TP-3	20	39.59899799	-119.7898894	4813	CAT-321 D LCR	Test Pit 12x3x20'
TP-4	20	39.5881868	-119.7902920	4822	CAT-321 D LCR	Test Pit 12x3x20'
TP-5	15	39.5871597	-119.7896369	4806	CAT-321 D LCR	Test Pit 12x3x15'
TP-6	17	39.5855300	-119.7896040	4834	CAT-321 D LCR	Test Pit 12x3x17'
TP-7	20	39.5838560	-119.7900120	4880	CAT-321 D LCR	Test Pit 12x3x20'
TP-8	20	39.5829950	-119.7904070	4898	CAT-321 D LCR	Test Pit 12x3x20'

A GES representative directed and supervised the subsurface explorations, while maintaining detailed logs of the subsurface conditions, classifying the soils encountered, and obtaining soil samples. The soils encountered were classified in general accordance with the Unified Soil Classification System (USCS). A Key to Symbols and Terms utilized on the exploration logs is presented on Figure No. A-3 along with the test pit logs in Appendix A.

Relatively deep subsurface information was also obtained by performing a refraction microtremor (ReMi) geophysical survey to assess the average shear wave velocity within the soil profile to a depth of approximately 100 feet. The ReMi survey is a non-destructive, surface-based test that utilizes passive sources of noise near the site (e.g. vehicle traffic, construction equipment, airplane traffic, etc.) as the sources of vibrations recorded by the ReMi equipment at the test location. The data is collected and processed, and then a shear wave velocity profile for the subsurface materials is created to fit the data. An average shear wave velocity is calculated from the profile and may be used for seismic considerations associated with design of the planned project. The results of the ReMi survey performed at the project site are presented in Section 4.5. The approximate location of the ReMi array is included in Appendix A on Figure A-2.

2.6. LABORATORY TESTING

The laboratory testing program consisted of tests to classify the on-site soils and to evaluate engineering and physical properties. The test results are presented on the exploration logs in Appendix A and on test reports presented in Appendix B. Detailed descriptions of the laboratory tests performed are also presented in Appendix B.

2.7. SUBSURFACE MATERIALS AND CONDITIONS

The following sections describe the soils encountered at the site. Detailed information regarding subsurface materials and conditions is presented on the test pit logs, Figure Nos. A-4 through A-11.

2.7.1. FILL

Approximately 8 feet of fill material was encountered in TP-1 found at the north end of the project site. Fill was not encountered in the other subsurface explorations. Fill placed without documentation to indicate that the fill soils were placed under the supervision of a Geotechnical Engineer are considered uncontrolled. The term uncontrolled fill soils refer to artificial fill which was placed without engineering observation, testing, or documentation and is considered unsuitable for the support of project improvements. Our scope did not include an evaluation of existing fill soils or certification of existing fill or improvements.

2.7.2. NATIVE SOIL

The native subsurface soils encountered in the test pits were generally observed as moist and firm to stiff sandy fat clay and dense silty sand with gravel underlain by bedrock. The bedrock was observed to consist of hydrothermally altered andesite.



**Figure 2.7.2 Native Material
from TP-6**

3. FINDINGS

Based on the results of our field exploration and laboratory testing programs, it is our opinion that there are no known geologic or geotechnical conditions that would prevent development of the project. It is also our opinion that there are some geotechnical considerations that may affect site development, including the presence of the Spanish Springs Valley Fault. A summary of geotechnical considerations is described below.

- The Spanish Springs Valley Fault runs through the property. Its location will have to be marked by an experienced geologist while excavating to ensure foundation locations are at least 5-feet away. Due to the proximity of the proposed buildings to the fault, some building locations may have to be adjusted.
- Based on the results of our review of available literature and the distance to mapped faults, it is our opinion that the potential for fault-related surface rupture at the site is low.
- Fill material was encountered towards the north end of the project site to a depth of approximately 8 feet. Any fill materials should be considered uncontrolled fill unless documentation of their placement and compaction is provided. The term “uncontrolled fill” refers to fill which was placed without engineering observation, testing, or documentation and is considered unsuitable in its present condition and needs to be excavated from structural areas. An evaluation of on-site fill soils is beyond the scope of services of this evaluation.
- Based on the results of our field exploration and laboratory testing and our understanding of the subject project, it is our opinion that the level of verification and inspection, should be **continuous** observation during earthwork operations.
- Fat clays were observed in the subsurface profile. Fat clays can be expansive and are not suitable for site improvements, foundations, and concrete slabs to be founded directly on. Expansive soils should be removed or approved structural fill placed to provide at least 3 feet clearance between bottom of foundations, concrete slabs and/or site improvements to top of fat clay layers.
- Collapsible soils were observed in the subsurface profile. Collapsible soils are not suitable for site improvements, foundations, and concrete slabs to be founded directly on. Collapsible soils should be removed or approved structural fill placed to provide at least 3 feet clearance between bottom of foundations, concrete slabs and/or site improvements to top of collapsible soils.
- The tested onsite soils have soluble soil chloride content that was either not detected or considered low, as evaluated by AWWA Standard Test Method SM4500-CI B.

- The tested soils at the site have a sulfate exposure class S0 as defined in Table 19.3.1.1 of American Concrete Institute (ACI) Publication 318-14. In accordance with Table 19.3.2.1 of ACI 318-14 concrete in contact with on-site soils along the subsurface walls up to 12 inches above finished grade should be designed for a sulfate exposure class S0 with no cement-type restriction and have a minimum design compressive strength of 2,500 pounds per square inch (psi).
- The tested soils had a solubility content of 0.73, 0.04, and 0.05 percent. Based on our experience, soils having solubility laboratory test results less than 2 percent by dry weight soluble solids as determined by American Water Works Association (AWWA) standard test method 2540 C are considered as having a low solubility.
- Based on the results of the ReMi test, a Seismic Site Class of C applies to the subject site.
- Based on the historical depth to groundwater, and the consistency of the onsite soils, it is our opinion that the potential for liquefaction at the site is low.

4. RECOMMENDATIONS

The following sections present recommendations concerning the proposed improvements at the project site. These recommendations are based upon our understanding of the project, the engineering properties of the tested on-site soils, the geologic conditions that are presented in this report, and the assumption that an adequate number of tests and observations will be made during construction to evaluate compliance with these recommendations.

4.1. EARTHWORK

Based on the results of our field exploration and laboratory testing programs, and our stated understanding of the proposed project, it is our opinion that the following earthwork recommendations are applicable to the project.

4.1.1. SITE PREPARATION

Where encountered, all existing uncontrolled fill, deleterious material, loose or disturbed native soils should be removed from improvement areas, and either removed from the site or processed to comply with the recommendations outlined in Section 4.1.2 for structural fill.

Due to the collapsible nature, expansion potential, and consistency of native soils as indicated by our subsurface explorations and laboratory testing, we recommend that one of the two options be considered to help mitigate these potential concerns.

1. On-site soils be overexcavated and replaced with a zone of processed, moisture conditioned approved structural fill as indicated below in Table 4.1.1-1. Or
2. Where the site will be raised, compacted structural fill be provided beneath site improvements, concrete slabs, and foundations to the depths/thicknesses summarized in Table 4.1.1-1 below. Overexcavation of subgrade can be eliminated where sufficient fill thickness will be added above current subgrade.

Table 4.1.1-1 Recommended Minimum Overexcavation Depths/ Fill Blanket Thickness

Structure Description	Recommended Minimum Depth of Overexcavation/ Fill Blanket Thickness
Structure Foundations & Slabs-On-Grade	3 feet below the bottom of footings or aggregate base
Asphalt Concrete Pavement & Concrete Flatwork	3 feet below the bottom of aggregate base for expansive soils or 12 inches where collapsible soils encountered and no expansive soils within 3 feet.

During construction, the geotechnical consultant should observe exposed materials after the removal of unsuitable materials to evaluate whether additional removal down to competent materials is needed. Overexcavation may terminate on very hard rock if encountered. After removal of materials as described above, the exposed native soils should be scarified to 8 inches or more, moisture conditioned to within 2 percent of optimum moisture content, and compacted to 95 percent relative compaction as evaluated by ASTM D1557. Scarification may terminate on very hard and dense soil if encountered, as evaluated by the geotechnical consultant. The soil preparation area should extend laterally a minimum of 5 feet beyond the edges of buildings and exterior foundations, where practical. For exterior concrete flatwork, the soil preparation area should extend laterally at least 2 feet beyond the edges. The vertical and lateral extent of the recommended excavations should be evaluated under the direction of the geotechnical consultant.

4.1.2. STRUCTURAL FILL AND BACKFILL SUITABILITY

Samples of materials proposed for use as structural fill should be submitted to the geotechnical consultant for testing and evaluation prior to being transported to the site. Imported materials and on-site materials that have been excavated, stockpiled, and processed for use as structural fill should satisfy the following recommendations:

Table 4.1.2-1 Imported and/or On-site Structural Fill Recommendations

Description*	Recommendation
4-inch Sieve Gradation**	100 Percent Passing
No. 200 Sieve Gradation**	40 Percent Passing
Liquid Limit	<50
Dry Weight Soluble Solids	<2.0% as determined by American Water Works Association (AWWA) Standard Method (SM) 2540 C
Dry Weight Soluble Sulfate	<0.2 % by dry weight soluble sulfate as determined by AWWA SM 4500 SO4 E
Soluble Soil Chloride Content	<500 ppm as determined by AWWA SM 4500-CL B unless appropriate corrosion protection is utilized in the design of proposed structures

* Imported fill materials and excavated on-site material should be free of debris, organic materials, and other deleterious materials.

**Materials used as retaining wall backfill should have 10 percent or less of material passing the No. 200 sieve, and 100 percent passing the 4-inch sieve.

4.1.3. FILL PLACEMENT

Areas to receive structural fill should be prepared prior to fill placement as described in Section 4.1.1 of this report. Structural fill should be uniformly moisture conditioned to within 2 percent optimum moisture content, placed in horizontal, loose lifts up to 12 inches thick, and compacted to 95 percent of the maximum dry density, as determined by ASTM D1557. The optimal lift thickness of fill will depend on the type of soil and compaction equipment used but should generally not exceed approximately 12 inches in loose thickness.

4.1.4. OBSERVATION AND TESTING

A qualified geotechnical consultant should perform appropriate observation and testing services during grading and construction operations. These services should include observation of removal of soft, loose, collapsible, expansive, or otherwise unsuitable soils, evaluation of subgrade conditions where soil removals are performed, and performance of observation and testing services during placement and compaction of structural fill and backfill soils. In-place density and moisture tests should be performed in accordance with ASTM D6938 or, alternatively, in accordance with ASTM D1556. The test frequency should be at least one test per 250 cubic yards of fill material placed or at least three tests per lift of fill material placed, whichever is more. Additional field tests may also be performed in structural and non-structural areas at the discretion of the geotechnical consultant.

Based on the results of our laboratory testing and our understanding of the subject project, it is our opinion that the level of verification and inspection should be continuous observations during earthwork operations.

4.2. EXCAVATION CONSIDERATIONS

The following section provides recommendations to aid in the successful performance of excavations at the project site.

4.2.1. TEMPORARY EXCAVATIONS

Temporary slope surfaces should be kept moist to retard raveling and sloughing. Water should not be allowed to flow over the top of excavations in an uncontrolled manner. Stockpiled material and/or equipment should be kept back from the top of excavations a distance equivalent to the depth of the excavation or more. Workers should be protected from falling debris, sloughing, and raveling in accordance with Occupational Safety and Health Administration (OSHA) regulations. Temporary excavations should be observed by the project's geotechnical consultant so that appropriate additional recommendations may be provided based on the actual field conditions. Temporary excavations are time sensitive, and failures are possible.

Excavations greater than 4 feet in depth into uncemented soils are not anticipated to stand vertically. Excavations greater than 4 feet in depth should be sloped back in accordance with the maximum allowable slope ratios presented in Appendix B to Subpart P of OSHA for the Construction Industry 29 Code of Federal Regulations (CFR), State of Nevada, Division of Occupational Safety and Health, Part 1926. The soil type definitions in Appendix A to Subpart P of OSHA 29 CFR, Part 1926 should be applied to soils encountered in excavations to determine the maximum allowable slope ratio. As an alternative to sloped excavation sidewalls, excavations could be shored and braced. Shoring and bracing should be designed in accordance with Appendices C and D to Subpart P of OSHA 29 CFR, Part 1926. Safety of construction personnel is the responsibility of the contractor.

4.3. UNDERGROUND UTILITIES

Soils placed as trench backfill in on-site utility trench excavations should meet the structural backfill criteria described in Section 4.1.2 of this report and should be moisture conditioned to within 2 percent of the optimum moisture content and compacted to at least 90 percent of the maximum dry density (ASTM D1557). Suitability and compaction of trench backfill should be evaluated during construction.

Soils proposed for use as trench backfill should be sampled and evaluated by the geotechnical consultant before placing. Trench backfill should be placed in loose lifts up to 8-inches thick, moisture conditioned to within 2 percent of the optimum moisture content, and compacted to a minimum of 90 percent of the soil's maximum dry density. The contractor should take care not to damage the pipe during backfilling. Trench backfill should be compacted by mechanical means only. Water densification methods should not be used to compact trench backfill.

Off-site utility trench backfill placement procedures should meet the specifications outlined in the latest edition of the Standard Specifications for Public Works Construction (the Orange Book) accepted by Washoe County.

4.4. FOUNDATIONS

The following sections present recommendations for shallow foundations including conventionally reinforced slabs-on-grade and post-tensioned slabs-on-grade.

4.4.1. SHALLOW FOUNDATIONS

Shallow footings (e.g. spread and continuous footings) supporting the proposed structures should be supported entirely on a zone of properly moisture conditioned and compacted structural fill, as previously described. Spread footings should be at least 12-inches wide and founded at least 24 inches below the lowest adjacent final compacted subgrade and should be reinforced in accordance with the project structural engineer's recommendations.

Footings may be designed based on an allowable net dead plus sustained live load bearing pressure of 2,600 pounds per square foot (psf). The allowable bearing pressure for conventional spread footings may be increased by 300 psf for each additional foot of embedment and/or 100 psf for each additional foot of width up to a maximum allowable pressure of 3,000 psf. The allowable bearing pressures may be increased by one-third for temporary wind or seismic loads. The allowable bearing pressure presented above includes a factor of safety against generalized bearing capacity failure of 3.0.

Resistance to lateral loads may be estimated using both passive lateral earth support and friction developing between footings and underlying soil. Passive resistance may be used if foundation backfill soils in front of the foundation are level and compacted to 90 percent, or more, of the maximum laboratory dry density (ASTM D1557). The upper 12 inches below the ground surface should be neglected if passive resistance is used. The passive lateral earth support for subsurface

walls may be estimated based on an equivalent fluid density of 370 pcf up to a maximum passive lateral pressure of 2,400 psf. A coefficient of friction of 0.39 may be used for the interface between the wall footing and underlying properly compacted structural fill. The values for the equivalent fluid density and coefficient of friction presented above do not include a specific factor of safety.

Provided that the earthwork recommendations presented are followed and structural loads are less than 50 kips for column loads and less than 3 kips per lineal foot for wall loads, total and differential settlements are not anticipated to exceed 1 and ½-inch, respectively. If structural loads exceed these values, GES should be provided the opportunity to re-evaluate our settlement estimates. Structural loads in excess of these estimates may result in increased settlement that could exceed the design tolerance of the structure.

4.4.2. CONVENTIONALLY REINFORCED SLABS-ON-GRADE

As a minimum, conventionally reinforced slabs-on-grade should be at least 4 inches thick with reinforcing designed by an experienced Structural Engineer based on the anticipated loading conditions. Aggregate base course materials beneath the floor slab-on-grade should be 4 inches or more thick and should consist of Type 2 Class B Aggregate Base materials, or other similar material acceptable to the geotechnical consultant, and be uniformly placed, moisture conditioned to within 2 percent of optimum moisture content, and compacted to at least 95 percent of the maximum dry density. The conventionally reinforced slab-on-grade foundation supported on Type 2 Aggregate Base may be designed using a vertical modulus of subgrade reaction (k_v) of 150 pounds per cubic inch.

Where moisture-sensitive floor coverings are used, a vapor retarder is recommended beneath slabs-on-grade and should consist of 10-mil minimum sheet plastic overlain by at least 4 inches of Type 2 class B Aggregate Base materials or other similar material approved by the Geotechnical Engineer. As a minimum, the vapor retarder should comply with the Class A rating as set forth in ASTM E1745. Installation of the vapor retarder should be performed in accordance with ASTM E1643.

4.4.3. POST-TENSIONED SLABS-ON-GRADE

Post-tensioned concrete foundation systems should be supported by properly placed and compacted structural fill as previously described. The thickened edges of post tensioned foundation systems should be established at least 24 inches below the lowest adjacent finished grade and should be at least 12-inches wide. Thickened edges of post-tensioned foundation systems should be designed based upon an allowable net dead plus sustained live load bearing pressure of 2,600 pounds per square foot, per Section 4.4.1.

The thickened edges of post-tensioned slabs-on-grade supporting structures should not be founded partially on properly compacted structural fill and partially on very hard rock. If both very hard rock and structural fill soils are present at the bottom of the footing excavation, the rock should be removed to a depth of at least 12 inches below bottom of footing and replaced with compacted structural fill.

Post-tensioned slabs should be designed for a differential soil movement value y_m of 1/2-inch for edge lift and 3/8-inch for center lift mode of deformation. An edge moisture variation distance, e_m , of 2.5 and 4.75 feet should be used for the edge lift and center lift modes of deformation, respectively. These recommendations are based on the assumption that post tensioned slabs are designed by a structural engineer in accordance with the design standards outlined in Section 1808.6.2 of the 2018 IBC.

A vapor retarder is recommended beneath the post-tensioned slabs-on-grade and should consist of 10-mil minimum sheet plastic overlain by at least 4-inches of Type 2 class B Aggregate Base materials or other similar materials approved by the Geotechnical Engineer and compacted to at least 95 percent of the maximum dry density. As a minimum, the vapor retarder should comply with the Class A rating as set forth in ASTM E 1745. Installation of the vapor retarder should be performed in general accordance with ASTM E 1643 and the manufacturer's recommendations.

4.5. SEISMIC SITE CLASS

Based on the results of the ReMi study performed at the project site, a Seismic Site Class C, in accordance with ASCE 7, may be used for this project. Figure 4.5-1 on the following page shows the results of the ReMi testing.

The following seismic design parameters based on ASCE 7-16 per the 2018 IBC for a Seismic Site Class C may be utilized using representative site coordinates of 39.585649 degrees latitude and -119.789632 degrees longitude with an assumed Risk Category of II:

Table 4.5-1 Spectral Response Accelerations and Site Coefficients – Site Class C

Spectral Response Acceleration at Short Periods, S_s	Spectral Response Acceleration at 1-Second Period, S_1	Spectral Response Coefficient at Short Periods, SD_s	Spectral Response Coefficient at 1-Second Period, SD_1	MCE _G Peak Ground Acceleration, PGA	Site Modified Peak Ground Acceleration, PGA _M
1.417g	0.494g	1.133g	Null*	1.2g	0.71g

* See Section 11.4.8 of ASCE 7-16

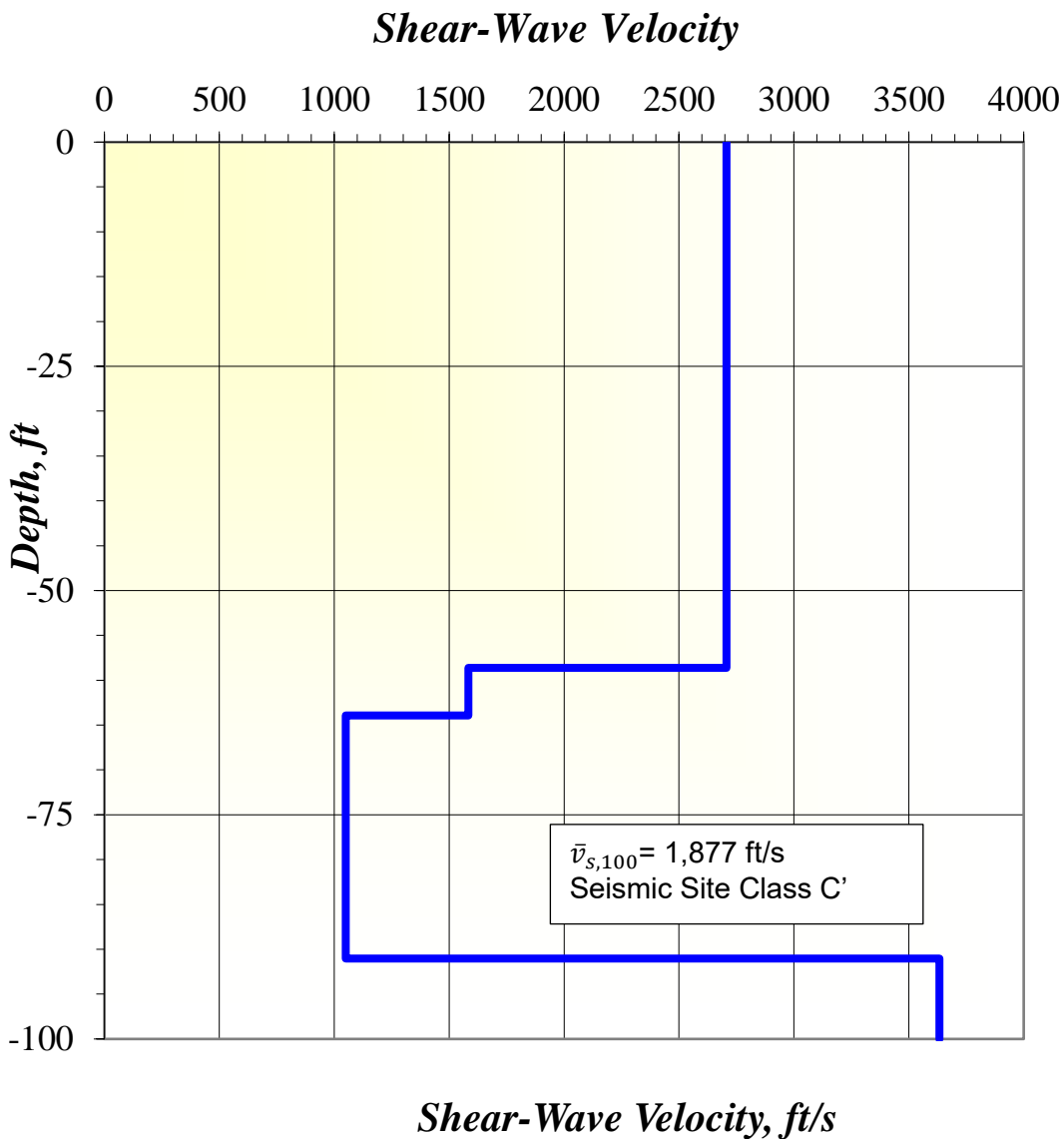

Figure 4.5-1 ReMi Field Test Results

4.6. LATERAL EARTH PRESSURES ON RETAINING WALLS

Retaining elements, if needed for the project, should be designed according to the recommendations in this report. Lateral active earth pressures induced by adjacent uniform surface surcharge loads should be estimated as a uniformly distributed lateral load with a magnitude equal to the magnitude of the surface surcharge load multiplied by an appropriate earth pressure coefficient. GES is presenting earth pressure coefficients for “active” and “at-rest” wall conditions. In the “active” condition the wall is able to deflect such that stresses from the retained soils are lessened. The “at rest” condition considers the walls to be rigid, or restrained, such that the walls do not deflect to lessen stresses from retained soils. Retaining walls with level backfill should be designed to resist the lateral earth pressures for the appropriate conditions presented in Figure C-1.

The values presented in Figure C-1 assume that the build-up of hydrostatic pressure will be prevented. To reduce the build-up of hydrostatic pressure, a wall drainage system, including weep-holes or a footing drainage system, daylighting to an appropriate outlet should be installed behind retaining walls. The wall drainage system should consist of a non-woven geotextile fabric having a maximum average Apparent Opening Size less than 0.43 mm (US Sieve #40) by ASTM D4751 and a minimum grab tensile strength of 120 pounds or more by ASTM D4632 wrapped around drain rock. Alternately, the wall drainage system may include a drain board (e.g., DrainStar Drain Board or equivalent) used in conjunction with a strip drain (e.g., DrainStar Stripdrain by Tremco Barrier Solutions, Inc., or equivalent). The strip drain should be a minimum of 12 inches in height and placed continuously along the bottom of the retaining wall.

Resistance to lateral loads for retaining wall foundations may be estimated using both passive lateral earth support and friction developing between the wall footing and underlying soil, as described in this report.

Materials used as retaining wall backfill which should have 10 percent, or less, of material passing the No. 200 sieve and 100 percent passing the 2-inch sieve. Backfill placed behind retaining walls or subsurface walls should consist of structural fill meeting the criteria presented in this report. Backfill placed behind retaining walls should be placed in 8-inch maximum vertical lifts and should be compacted to between 90 and 95 percent of the maximum laboratory dry density as determined per ASTM D1557. Over-compaction adjacent to retaining walls or subsurface walls should be avoided. The lateral earth pressures shown on Figure C-1 assume that compaction

behind retaining walls or subsurface walls will be accomplished with relatively light compaction equipment.

4.7. EXTERIOR CONCRETE FLATWORK CONSTRUCTION

Concrete flatwork should be at least 4 inches in thickness. Aggregate base course materials beneath concrete flatwork should be at least 4 inches in thickness and should consist of Type 2 Class B Aggregate Base or other similar material approved by the Geotechnical Engineer. Aggregate base should be uniformly placed and compacted to at least 95 percent of the maximum dry density.

The subgrade soils beneath concrete flatwork should be prepared as described in this report, including moisture-conditioning within 2 percent of optimum moisture, and compacting to 95 percent, of the maximum dry density as determined by ASTM D1557 prior to the placement of supportive aggregate base.

Excessive slump (due to a high water-cement ratio) of the concrete and/or improper curing procedures could lead to excessive shrinkage, cracking or curling of slabs and other flatwork. Concrete placement and curing operations should be performed in accordance with the American Concrete Institute (ACI) Manual of Concrete Practice (ACI, 2014).

4.8. MINIMUM RECOMMENDED ASPHALT PAVEMENT SECTIONS

A design R-value of 5 was used for calculating recommended asphalt concrete pavement sections for driveways and parking areas associated with the planned improvements. The recommended minimum sections were calculated using WinPAS software Version 1.0.4 using a standard deviation of 0.45, initial serviceability of 4.2, terminal serviceability of 2.5, reliability factor of 80 percent, and an R-value of 5. Average Daily Traffic (ADT) was estimated based on anticipated traffic conditions for on-site parking and driveway areas in accordance with Washoe County Standard Details, Drawing W-1.2. If the traffic loadings are not representative of anticipated traffic, then our office should be notified to reevaluate the recommended pavement sections.

Table 4.8-1 Recommended Minimum Asphalt Concrete Pavement Sections

Loading Condition	ADT	Asphalt Thickness (Inches)	Type 2 Class B Aggregate Base Thickness (Inches)
Parking Areas	1,000	4	8
Driveways	2,000	4	12

The recommended pavement sections assume that subgrade soils will have an R-value of 5 or more and that the traffic loadings presented in Table 4.9-1 are expected. If soils with an R-value less than 5 are observed as subgrade beneath pavement sections and the assumed traffic loadings are not representative of anticipated traffic, the recommended pavement sections will need to be reevaluated.

4.9. MINIMUM RECOMMENDED RIGID PAVEMENT SECTIONS

A rigid concrete pavement section may be considered for access and parking areas; rigid pavement should be considered for dumpster approaches and in areas with high truck or bus traffic. To form a basis for design of rigid pavement for on-site paved areas, using WinPAS software, Version 1.0.4, with 80 percent reliability, standard deviation of 0.45, initial serviceability of 4.2, terminal serviceability of 2.5, Modulus of Subgrade Reaction of 100 psi/in, and traffic loadings described in the previous section, the following minimum rigid pavement sections are recommended. If the traffic loadings are not representative of anticipated traffic, then our office should be notified to reevaluate the recommended pavement sections.

Table 4.9-1 Recommended Minimum Rigid Pavement Sections

Loading Condition	ADT	Portland Cement Concrete Thickness (Inches)	Type 2 Class B Aggregate Base Thickness (Inches)
Parking Areas	1,000	4	4
Driveways	2,000	4.5	4

The recommended pavement sections assume subgrade soils will have an R-value of 5 or more. If soils with R-values less than 5 are observed as subgrade beneath pavement sections, the recommended pavement sections will need to be reevaluated. Joint spacing, steel reinforcing, doweling, and/or curing procedures should be incorporated into the final rigid pavement design by the project structural or civil engineer to resist shrinkage, cracking, or curling. Concrete design, placement and curing operations should be performed in accordance with the American Concrete Institute (ACI) Manual of Concrete Practice (ACI, 2014).

Compacted subgrade should comply with the recommendations provided in Section 4.1. Structural fill, including scarified and recompacted native subgrade soils, below pavement section should be compacted to 95 percent or more relative compaction and Type 2 Class B Aggregate Base materials should be placed and compacted to 95 percent or more relative compaction, as evaluated by AASHTO T180.

4.10. SOIL CORROSIVITY

Based on the results of the reviewed chemical testing, the tested on-site soils have a negligible sulfate exposure as described in Table 19.3.1.1 of American Concrete Institute (ACI) Publication 318-14. In accordance with ACI 318-14, concrete in contact with on-site soils along with subsurface walls up to 12 inches above finished grade be designed as follows:

Table 4.10-1 Concrete Recommendations for Severe Sulfate Exposure

Description	Recommendation per ACI 318-14
Cement Type	No Type Restriction
28- Day Design Compressive Strength	2,500 psi
Water to Cement Ratio	0.50
Slump	4 inches

In addition, it is recommended that reinforcing bars in cast-against-grade concrete, with the exception of slab-on-grade floors and exterior concrete flatwork, be covered by approximately 3 inches or more of concrete. Structural concrete should be placed in accordance with American Concrete Institute and project specifications.

We recommend that a Corrosion Engineer be consulted for protection recommendations for any buried metal pipe. Metal pipe may be protected by using cathodic protection or pipe coatings and wrappings, or, as an alternative, PVC pipe may be used if allowed by jurisdictional building codes.

4.11. DRAINAGE AND MOISTURE PROTECTION

Infiltration of water into subsurface soils can lead to soil movement and associated distress, and chemically and physically related deterioration of concrete structures. To reduce the potential for infiltration of moisture into subsurface soils at the site, we recommend the following:

- Positive drainage should be established and maintained away from the proposed building(s). drainage may be established by sloping the ground immediately adjacent to foundations away from building(s) with a slope of at least 5 percent for a distance of at least 10 feet measured perpendicular to the building wall from building foundations. Where physical obstructions prohibit 10-feet of horizontal distance from foundations, a 5 percent slope should be provided to an alternate method of diverting water away from foundations such as swales parallel to the foundations with a flow line slope of at least 1 percent. Impervious surfaces should have a surface gradient of 2 percent or more.
- Adequate surface drainage should be provided to channel surface water away from on-site structures and to a suitable outlet such as a storm drain or the street. Adequate surface drainage may be enhanced by utilization of graded swales, area drains, and other drainage devices. Surface run-off should not be allowed to pond near structures.

- Building roof drains should have downspouts tight lined to an appropriate outlet, such as a storm drain or the street. If tight lining of the downspouts is not practicable, they should discharge 5 feet or more away from the building or onto concrete flatwork or asphalt that slopes away from the structure. Downspouts should not be allowed to discharge onto the ground surface adjacent to building foundations.
- Low-water use (drip irrigated) landscaping is recommended for use on-site, particularly within 5 feet of the building and exterior site improvements, including areas of concrete flatwork and masonry block walls.
- Irrigation heads should be oriented so that they spray away from building and block wall surfaces.
- A relatively impermeable barrier should be placed against retaining structures where retained soil is in contact with the retaining wall so that unsightly staining of the exposed wall face and potential for degradation of the wall will be reduced.
- Graded slopes may be subject to erosion, surface runoff over slopes should be controlled. To reduce the potential for erosion caused by surficial drainage over slopes, swales and/or interceptor drains as described in Section J109 of the 2018 IBC (ICC, 2017) may be placed at the top of the slope.
- The face of slopes should be prepared and maintained to control erosion. Erosion controls should be installed as soon as practical after grading. Erosion control may include ground cover, hardscaping, and/or lightweight, deep rooted landscaping requiring low water use. Whether erosion control measures are used or not, periodic maintenance of slopes will likely be required.
- Paved areas should have a surface gradient of 2 percent, or more. In addition, surface runoff from surrounding areas should be intercepted, collected, and not permitted to flow onto the pavement or to infiltrate the base and subgrade. We recommend that perimeter swales, edge drains, curbs and gutters, or combination of drainage devices, be construed to reduce the adverse effects of surface water runoff.

4.12. PRE-CONSTRUCTION MEETING

We recommend that a pre-construction meeting be held. The owner or the owner's representative, the architect/engineer of record, the contractor, material testing firm, and the geotechnical consultant should be in attendance to discuss the plans and the project.

4.13. CONTINUITY

GES, Inc. is an IAS Accredited Special Inspection Agency that can provide construction materials testing and observations services during the construction of this project. Consideration should be given to the benefit from continuity in service that is provided when the owner's geotechnical consultant is involved in both the design and construction of the project.

5. LIMITATIONS

The recommendations contained in this report are based on field exploration, laboratory testing, research of pertinent maps and literature, and our understanding of the proposed construction. The soil data used in the preparation of this report were obtained from 8 test pits performed at the site. It is possible that variation in the soil conditions will exist between the locations explored. Therefore, if any soil conditions are encountered at the site that are different from those outlined in this report, Geotechnical & Environmental Services, Inc. should be immediately notified so that we may review the situation that exists and make supplementary recommendations as needed. In addition, if the scope of the proposed construction, including the types of structures, anticipated loads and maximum cut and fill depths, changes from what is described in this report, our firm should be notified. A detailed excavatability or rippability evaluation is beyond the scope of this study.

The recommendations presented in this report are based on the assumption that an adequate number of tests and observations will be made during site construction to evaluate compliance with the recommendations. These tests and observations should be provided under the direction of a qualified Geotechnical Engineer. Such testing and observations should include but not be limited to the following:

- Review of site construction plans for conformance with the soils investigation.
- Observation and testing during site preparation, grading, footing and other excavations, and placement of fill, aggregate base, and concrete.
- Consultation as may be required during construction.

Our services were performed using that degree of care and skill ordinarily exercised under similar circumstances by reputable engineering firms in this or similar localities. No other warranties, either express or implied, are included or intended in this report.

6. REFERENCES

American Concrete Institute (ACI), 2014, ACI Manual of Concrete Practice.

American Society for Testing and Materials (ASTM), 2011, Annual Book of ASTM Standards, Section 4 – Construction Volumes 04.02, 04.08, and 04.09

Douglas County (NV) GIS Douglas County Public Viewer (arcgis.com)

Geotechnical & Environmental Services, Inc., proprietary in-house data

Google Earth, Imagery date May 31, 2018 at approximate location 39.09627° latitude and -119.84964° longitude, accessed on December 2, 2021

International Code Council, 2018 International Building Code

Occupational Safety and Health Administration (OSHA), 2002, OSHA Standards for the Construction Industry, 29 CFR Part 1926.

OSHPD Seismic Design Maps; <https://seismicmaps.org/>

Ramelli, A.R., Henry, C.D, and Walker, J.P, *with contributions by* Bell, J.W., Cashman, P.H., dePolo, C.M, Garside, L.J., House, P.K., Trexler, J.H., and Widmer, M.C., 2011, Preliminary revised geological maps of the Reno Urban area, Nevada: Nevada Bureau of Mines and Geology Open-File Report 11-7, 3 plates, scale 1:24,000.

State of Nevada Department of Conservation & Natural Resources, Division of Water Resources, 2019, Well Log Database: <http://water.nv.gov/data/welllog/index.cfm>

United States Geological Survey (USGS), Quaternary Faults and Folds Database of the United States:

<https://usgs.maps.arcgis.com/apps/webappviewer/index.html?id=5a6038b3a1684561a9b0aadf88412fcf>



APPENDIX A – SUBSURFACE STUDY



Approximate Project Location

Source: Esri, Maxar, GeoEye, Earthstar Geographics, CNES/Airbus DS, USDA, USGS, AeroGRID, IGN, and the GIS User Community, Esri, HERE, Garmin, (c) OpenStreetMap contributors, Esri, HERE, Garmin, (c) OpenStreetMap contributors, and the GIS user community

Legend

★ Approximate Project Location

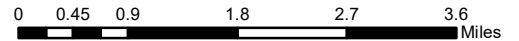

GEOTECHNICAL & ENVIRONMENTAL SERVICES, INC.

7150 Placid St.
Las Vegas, NV 89119

702-365-1001
www.gesnevada.com

NOTE: Data presented on this map is a compilation of GIS Metadata extracted from a variety of sources. Transportation data and Imagery are courtesy of ESRI. This data is downloaded by GES for incorporation into drawings generated by GES. Data contained within this page is to be used for informational purposes only. GES has not modified the data contained herein and uses it as it is acquired from the respective agency.



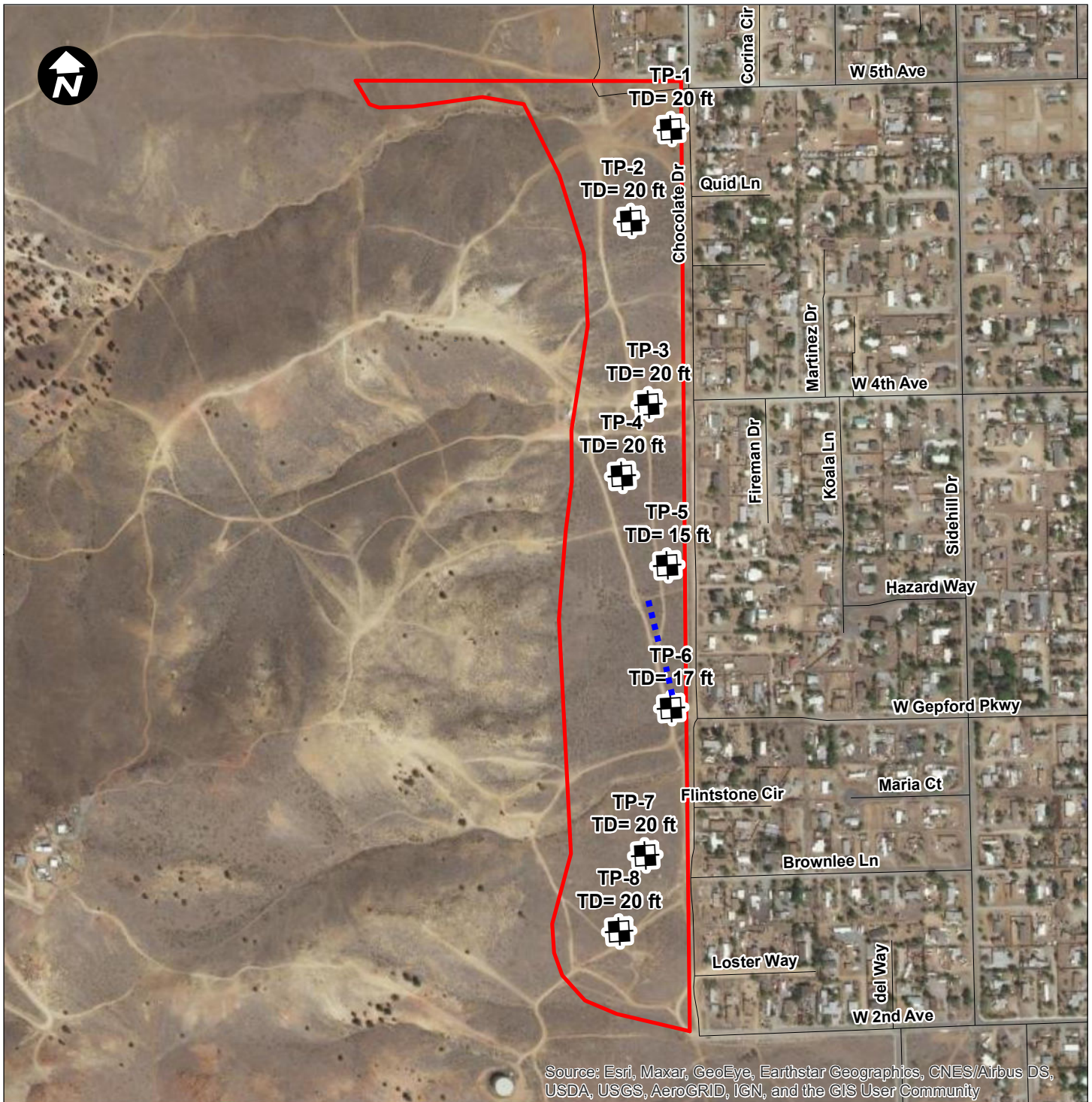

SITE VICINITY MAP
6400 CHOCOLATE DRIVE
MULTI-FAMILY RESIDENCES
SUN VALLEY, NEVADA

Drawn By: JJB	Date Drawn: 12/30/2021
Project No. R20215772E1	Figure No. A-1



Source: Esri, Maxar, GeoEye, Earthstar Geographics, CNES/Airbus DS, USDA, USGS, AeroGRID, IGN, and the GIS User Community

Legend

-  TP-1 Approximate Test Pit Location
-  Approximate Site Boundary
-  Street Centerline
-  Approximate ReMi Location

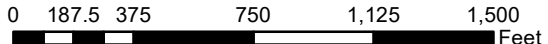

GEOTECHNICAL & ENVIRONMENTAL SERVICES, INC.
 7150 Placid St.
 Las Vegas, NV 89119
 702-365-1001
 www.gesnevada.com

NOTE: Data presented on this map is a compilation of GIS Metadata extracted from a variety of sources. Street centerline and name data was obtained from the USGS. This data is downloaded by GES for incorporation into drawings generated by GES. Data contained within this page is to be used for informational purposes only. GES has not modified the data contained herein and uses it as it is acquired from the respective agency.

EXPLORATION LOCATION MAP 6400 CHOCOLATE DRIVE MULTI-FAMILY RESIDENCES SUN VALLEY, NEVADA	Drawn By: JJB	Date Drawn: 12/30/2021
	Project No. R20215772E1	Figure No. A-2

KEY TO SYMBOLS AND TERMS

Terms used according to the Unified Soil Classification System

Consistency or Condition of Soils

Fine-Grained Soils (Silt and Clay): Major portion passing #200 sieve

California Sampler* (blows/foot)	SPT** (blows/foot)	Relative Consistency	Unconfined Compressive Strength (tsf)	Manual Manipulation
< 2	< 2	Very Soft	< 0.25	Thumb will penetrate soil more than 1 in.
2-5	2-4	Soft	0.25-0.50	Thumb will penetrate soil about 1 in.
5-10	4-8	Firm	0.50-1.00	Thumb will penetrate soil about ¼ in.
10-20	8-15	Stiff	1.00-2.00	Thumb will not indent soil but readily indented with thumbnail.
>20	>15	Very Stiff	>2.00	Thumbnail will not indent soil.

*ASTM D3550 using a 140-pound hammer falling 30 inches.

**ASTM D1586

Coarse-Grained Soils (Sand and Gravel): Major portion retained on #200 sieve

California Sampler* (blows/foot)	SPT** (blows/foot)	Relative Density	Behavior of ½-inch Diameter Probe Rod
0-7	0-4	Very Loose	Easily penetrated when pushed by hand.
7-18	4-10	Loose	Firmly penetrated when pushed by hand.
18-50	10-30	Medium Dense	Easily penetrated when driven by 1 lb. hammer.
50-70	30-50	Dense	Penetrated less than 1 inch when driven with a 1 lb. hammer.
>70	>50	Very Dense	Penetrated less than ¼ inch when driven with a 1 lb. hammer.

*ASTM D3550 using a 140-pound hammer falling 30 inches.

**ASTM D1586

Cementation	Characteristic
Weak	Crumbles or breaks with handling or little finger pressure.
Moderate	Crumbles or breaks with considerable finger pressure.
Strong	Will not crumble or break with finger pressure.

Hardness	Characteristic
Moderately Hard	Can be readily scratched by a knife blade; scratch leaves a heavy trace of dust and scratch is readily visible after the powder has been blown away.
Hard	Can be scratched with difficulty; scratch produces little powder and is often faintly visible; traces of the knife steel may be visible.
Very Hard	Cannot be scratched with pocket knife. Leave knife steel marks on surface.

Laboratory Testing Acronyms & Abbreviations

AL = Atterberg Limits	Corr = Corrosion Suite	MD = Moisture Content/ Dry Density	R-Val = R-Value
Consol = Consolidation	DS = Direct Shear	OC = Organic Content	SA = Sieve Analysis
CBR = California Bearing Ratio	MC = Moisture Content	PROC = Proctor	SPG = Specific Gravity
	UU = Unconsolidated Undrained Triaxial Test		

Strata Group Symbols

	AC - Asphalt Concrete
	PCC - Portland Cement Concrete
	CL - Low plasticity clay
	CH - High plasticity clay
	CL-ML - Silty low plasticity clay
	ML - Silt
	MH - Elastic silt
	SC - Clayey sand
	SM - Silty sand
	SP - Poorly graded sand
	SW - Well - graded sand
	GC - Clayey Gravel
	GM - Silty gravel
	GP - Poorly graded gravel
	GW - Well - graded gravel
	CSG - Cemented sand and gravel
	CALI - Caliche

Soil Sampler Symbols

	Air Knife
	Bulk Sample
	California Sampler
	Standard Penetration Test
	Core Barrel
	Shelby Tube

Misc. Symbols

	Exploration continues
	Initial groundwater depth
	Measured groundwater depth (after 24 hours or more)

Constituent Percentages

Trace - < 5%
Few - 5 to 10%
Little - 15-25%
Some - 30-45%
Mostly - 50-100%

Moisture Condition

Dry - Absence of moisture, dusty, dry to the touch
Moist - Damp but no visible water
Wet - Visible free water, usually soil is below water table

Notes

1. Subsurface explorations were performed using the equipment listed on the exploration logs.
2. Subsurface explorations were performed on the date(s) shown on the exploration logs.
3. Soil sampler(s) were driven with a 140 pound hammer falling 30 inches (unless otherwise noted in the text of this report).
4. The transitions between soil types shown on the exploration logs as occurring abruptly at particular depths in actuality may be a gradual progression from one soil type to the next.
5. Exploration logs are subject to the limitations, conclusions, and recommendations presented in this report.
6. DR = Drilling Rate (min/ft)

Disclaimer

This Key to Symbols and Terms is part of a report prepared by Geotechnical & Environmental Services, Inc. and should be used with the report. The descriptions on the exploration logs apply only at the specific exploration locations and at the time the explorations were made. They are not warranted to be representative of subsurface conditions at other locations or times.

Figure No. A-3



PROJECT NAME Chocolate Drive CLIENT Pedcor, LLC
 PROJECT NUMBER R20215772E1 PROJECT LOCATION Sun Valley, Nevada
 DATE STARTED 11/15/21 COMPLETED 11/15/21 GROUND ELEVATION 4801 ft TEST PIT SIZE 12x3x20 feet
 EXCAVATION CONTRACTOR Waters Vaccum Truck Service GROUND WATER LEVELS:
 EXCAVATION METHOD Test Pit AT TIME OF EXCAVATION Not Encountered
 LOGGED BY S. Solares DRILLER Waters AT END OF EXCAVATION N/A
 LAT. 39.5921357 LONG. -119.7895115 AFTER EXCAVATION N/A

DEPTH (ft)	BULK SAMPLE SAMPLER TYPE	TESTS	U.S.C.S. GRAPHIC LOG	MATERIAL DESCRIPTION
0				
			CH	<u>FILL</u> : Dark brown fat CLAY, moist, stiff. 4.0 4797.0
5			ML	White SILT, moist, stiff. 8.0 4793.0
10		MC = 16% LL = 51 PL = 28 Fines = 50%	CH	<u>NATIVE</u> : Orange brown sandy fat CLAY, slightly moist, very stiff. 20.0 4781.0
15				
20				Bottom of test pit at 20.0 feet.



GENERAL_BH/TP/WELL - GES - GES_GEOTECHNICAL_STD.GDT - 1/10/22 12:49 - J:\GES\CLIENTS\RENO OFFICE\PROJECTS\2021\R20215772E1\GPJ

The descriptions contained within this exploration log apply only at the specific exploration location and at the time the exploration was made. It is not intended to be representative of subsurface conditions at other locations or times.

Figure No. A-4



PROJECT NAME Chocolate Drive CLIENT Pedcor, LLC
 PROJECT NUMBER R20215772E1 PROJECT LOCATION Sun Valley, Nevada
 DATE STARTED 11/15/21 COMPLETED 11/15/21 GROUND ELEVATION 4807 ft TEST PIT SIZE 12x3x20 feet
 EXCAVATION CONTRACTOR Waters Vaccum Truck Service GROUND WATER LEVELS:
 EXCAVATION METHOD Test Pit AT TIME OF EXCAVATION Not Encountered
 LOGGED BY S. Solares DRILLER Waters AT END OF EXCAVATION N/A
 LAT. 39.5910924 LONG. -119.790113 AFTER EXCAVATION N/A

DEPTH (ft)	BULK SAMPLE	SAMPLER TYPE	U.S.C.S.	GRAPHIC LOG	MATERIAL DESCRIPTION
0					
			CH		NATIVE: Brown fat CLAY, slightly moist, stiff.
4.0					4803.0
5			CL		Light orange brown lean CLAY, moist, stiff, with white diatomaceous material.
10					
15					
20					4787.0
Bottom of test pit at 20.0 feet.					

GENERAL BH/TP/WELL - GES - GES - GEOTECHNICAL - STD.GDT - 1/10/22 12:49 - J:\GES\CLIENTS\RENO OFFICE\PROJECTS\2021\R20215772E1\GPJ

The descriptions contained within this exploration log apply only at the specific exploration location and at the time the exploration was made. It is not intended to be representative of subsurface conditions at other locations or times.

Figure No. A-5

PROJECT NAME Chocolate Drive CLIENT Pedcor, LLC
 PROJECT NUMBER R20215772E1 PROJECT LOCATION Sun Valley, Nevada
 DATE STARTED 11/15/21 COMPLETED 11/15/21 GROUND ELEVATION 4813 ft TEST PIT SIZE 12x3x20 feet
 EXCAVATION CONTRACTOR Waters Vaccum Truck Service GROUND WATER LEVELS:
 EXCAVATION METHOD Test Pit AT TIME OF EXCAVATION Not Encountered
 LOGGED BY S. Solares DRILLER Waters AT END OF EXCAVATION N/A
 LAT. 39.58899799 LONG. -119.7898894 AFTER EXCAVATION N/A

DEPTH (ft)	BULK SAMPLE SAMPLER TYPE	TESTS	U.S.C.S. GRAPHIC LOG	MATERIAL DESCRIPTION
0				
			CH	NATIVE: Dark brown fat CLAY, moist, stiff.
				4810.0
5		MC = 11% LL = 46 PL = 33 Fines = 23% Swell = -3%	SM	Orange silty SAND with gravel, moist, dense. ... increasing coarse material, firm.
10				4801.0
			MH	Reddish elastic SILT, moist, soft.
15				
20				4793.0
Bottom of test pit at 20.0 feet.				

GENERAL BH/TP/WELL - GES - GES_GEOTECHNICAL_STD.GDT - 1/10/22 12:49 - J:\GES\CLIENTS\RENO OFFICE\PROJECTS\2021\R20215772E1\GPJ

The descriptions contained within this exploration log apply only at the specific exploration location and at the time the exploration was made. It is not intended to be representative of subsurface conditions at other locations or times.

Figure No. A-6



PROJECT NAME Chocolate Drive CLIENT Pedcor, LLC
 PROJECT NUMBER R20215772E1 PROJECT LOCATION Sun Valley, Nevada
 DATE STARTED 11/15/21 COMPLETED 11/15/21 GROUND ELEVATION 4822 ft TEST PIT SIZE 12x3x20 feet
 EXCAVATION CONTRACTOR Waters Vacuum Truck Service GROUND WATER LEVELS:
 EXCAVATION METHOD Test Pit AT TIME OF EXCAVATION Not Encountered
 LOGGED BY J. Roybal DRILLER Waters AT END OF EXCAVATION N/A
 LAT. 39.5881868 LONG. -119.790292 AFTER EXCAVATION N/A

DEPTH (ft)	BULK SAMPLE	SAMPLER TYPE	U.S.C.S.	GRAPHIC LOG	MATERIAL DESCRIPTION
0					
0					NATIVE: Dark brown lean CLAY, moist, stiff.
5					... brown, very stiff, with gravel.
10			CL		
15					15.0 4807.0
15					Brown to orange well-graded SAND with silt and gravel, slightly moist, medium dense.
20			SW-SM		
20					20.0 4802.0
					Bottom of test pit at 20.0 feet.

GENERAL BH/TP/WELL - GES - GES_GEOTECHNICAL_STD.GDT - 1/10/22 12:49 - J:\GES\CLIENTS\RENO OFFICE\PROJECTS\2021\R20215772\R20215772E1.GPJ

The descriptions contained within this exploration log apply only at the specific exploration location and at the time the exploration was made. It is not intended to be representative of subsurface conditions at other locations or times.

Figure No. A-7

PROJECT NAME Chocolate Drive CLIENT Pedcor, LLC
 PROJECT NUMBER R20215772E1 PROJECT LOCATION Sun Valley, Nevada
 DATE STARTED 11/15/21 COMPLETED 11/15/21 GROUND ELEVATION 4806 ft TEST PIT SIZE 12x3x20 feet
 EXCAVATION CONTRACTOR Waters Vaccum Truck Service GROUND WATER LEVELS:
 EXCAVATION METHOD Test Pit AT TIME OF EXCAVATION Not Encountered
 LOGGED BY J. Roybal DRILLER Waters AT END OF EXCAVATION N/A
 LAT. 39.5871597 LONG. -119.7896369 AFTER EXCAVATION N/A

DEPTH (ft)	BULK SAMPLE SAMPLER TYPE	TESTS	U.S.C.S. GRAPHIC LOG	MATERIAL DESCRIPTION
0				
5		MC = 6% LL = NP PL = NP Fines = 17% Swell = 0%	SM	NATIVE: Dark brown silty SAND with gravel, moist, loose. ... very dense.
15				Refusal at 15.0 feet. Bottom of test pit at 15.0 feet.

GENERAL_BH/TP/WELL - GES - GES_GEOTECHNICAL_STD.GDT - 1/10/22 12:49 - J:\GES\CLIENTS\RENO OFFICE\PROJECTS\2021\R20215772\R20215772E1.GPJ

The descriptions contained within this exploration log apply only at the specific exploration location and at the time the exploration was made. It is not intended to be representative of subsurface conditions at other locations or times.

Figure No. A-8

PROJECT NAME Chocolate Drive CLIENT Pedcor, LLC
 PROJECT NUMBER R20215772E1 PROJECT LOCATION Sun Valley, Nevada
 DATE STARTED 11/16/21 COMPLETED 11/16/21 GROUND ELEVATION 4834 ft TEST PIT SIZE 12x3x20 feet
 EXCAVATION CONTRACTOR Waters Vaccum Truck Service GROUND WATER LEVELS:
 EXCAVATION METHOD Test Pit AT TIME OF EXCAVATION Not Encountered
 LOGGED BY S. Solares DRILLER Waters AT END OF EXCAVATION N/A
 LAT. 39.58553 LONG. -119.789604 AFTER EXCAVATION N/A

DEPTH (ft)	BULK SAMPLE SAMPLER TYPE	TESTS	U.S.C.S. GRAPHIC LOG	MATERIAL DESCRIPTION
0				
5			SC	NATIVE: Brown clayey SAND with gravel, moist, medium dense.
5.0		MC = 7% LL = 25 PL = 22 Fines = 22%		Brown silty SAND with gravel, moist, dense, weakly to moderately cemented.
10			SM	... loose to medium dense.
15				... dense to very dense.
17.0				Refusal at 17.0 feet. Bottom of test pit at 17.0 feet.

GENERAL_BH/TP/WELL - GES - GES - GEOTECHNICAL STD.GDT - 1/10/22 12:49 - J:\GES\CLIENTS\RENO OFFICE\PROJECTS\2021\R20215772\R20215772E1.GPJ

The descriptions contained within this exploration log apply only at the specific exploration location and at the time the exploration was made. It is not intended to be representative of subsurface conditions at other locations or times.

Figure No. A-9

PROJECT NAME Chocolate Drive CLIENT Pedcor, LLC
 PROJECT NUMBER R20215772E1 PROJECT LOCATION Sun Valley, Nevada
 DATE STARTED 11/16/21 COMPLETED 11/16/21 GROUND ELEVATION 4880 ft TEST PIT SIZE 12x3x20 feet
 EXCAVATION CONTRACTOR Waters Vaccum Truck Service GROUND WATER LEVELS:
 EXCAVATION METHOD Test Pit AT TIME OF EXCAVATION Not Encountered
 LOGGED BY S. Solares DRILLER Waters AT END OF EXCAVATION N/A
 LAT. 39.583856 LONG. -119.790012 AFTER EXCAVATION N/A





DEPTH (ft)	BULK SAMPLE SAMPLER TYPE	TESTS	U.S.C.S. GRAPHIC LOG	MATERIAL DESCRIPTION
0				
0 to 2.0			SC	NATIVE: Light orange brown clayey SAND with gravel, moist, dense to very dense, moderate to strong cementation, angular gravel. 4878.0
2.0 to 11.0				Reddish brown with white rock fragments in a clayey sand matrix, slightly moist, hard, cobble to boulder-sized rock fragments. 4869.0
11.0 to 15.0		MC = 3% LL = 43 PL = 34 Fines = 24%		Light yellow orange silty SAND with gravel, moist, stiff, weakly to moderately cemented, with diatomaceous material. 4860.0
15.0 to 20.0			SM	... very stiff. 4860.0
Bottom of test pit at 20.0 feet.				

GENERAL BH/TP/WELL - GES - GES_GEOTECHNICAL_STD.GDT - 1/10/22 12:49 - J:\GES\CLIENTS\RENO OFFICE\PROJECTS\2021\R20215772\R20215772E1.GPJ

The descriptions contained within this exploration log apply only at the specific exploration location and at the time the exploration was made. It is not intended to be representative of subsurface conditions at other locations or times.

Figure No. A-10

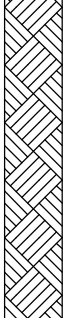
PROJECT NAME Chocolate Drive CLIENT Pedcor, LLC
 PROJECT NUMBER R20215772E1 PROJECT LOCATION Sun Valley, Nevada
 DATE STARTED 11/16/21 COMPLETED 11/16/21 GROUND ELEVATION 4898 ft TEST PIT SIZE 12x3x20 feet
 EXCAVATION CONTRACTOR Waters Vacuum Truck Service GROUND WATER LEVELS:
 EXCAVATION METHOD Test Pit AT TIME OF EXCAVATION Not Encountered
 LOGGED BY S. Solares DRILLER Waters AT END OF EXCAVATION N/A
 LAT. 39.582995 LONG. -119.790407 AFTER EXCAVATION N/A

DEPTH (ft)	BULK SAMPLE	SAMPLER TYPE	U.S.C.S.	GRAPHIC LOG	MATERIAL DESCRIPTION
0					
			CL		NATIVE: Red brown sandy lean CLAY, moist, stiff to very stiff.
5					
					Whitish to light red rock fragments in a clayey sand matrix, slightly moist, hard, cobble to boulder-sized fragments, with diatomaceous material.
6.0					4892.0
10					
					... light yellow orange.
15					
					... decreasing fines observed.
20					
					4878.0
Bottom of test pit at 20.0 feet.					

GENERAL_BH/TP/WELL - GES - GES - GEOTECHNICAL - STD.GDT - 1/10/22 12:49 - J:\GES\CLIENTS\RENO OFFICE\PROJECTS\2021\R20215772E1\20215772E1.GPJ

The descriptions contained within this exploration log apply only at the specific exploration location and at the time the exploration was made. It is not intended to be representative of subsurface conditions at other locations or times.

Figure No. A-11



APPENDIX B – LABORATORY TEST RESULTS

GEOTECHNICAL EVALUATION
6400 CHOCOLATE DRIVE
MULTI-FAMILY RESIDENCES
SUN VALLEY, NEVADA

Laboratory tests were conducted on representative soil samples for the purpose of classification and to evaluate their engineering and physical properties. The amount and selection of the types of testing for a given study are based on the geotechnical conditions of the project. A summary of the various laboratory tests conducted for this project are presented below.

1. IN-PLACE MOISTURE CONTENT

The in-place moisture contents of selected soil samples obtained from the bulk samples were evaluated. For each sample, the wet weight of the sample was obtained. The samples were then oven-dried. After drying, the dry weight of each sample was measured, and the subsequent moisture contents calculated. The moisture contents of the sampled soils are presented at the respective sample depth on the exploration logs in Appendix A.

2. GRAIN SIZE DISTRIBUTION

Five size distribution tests were performed by sieve analysis in general accordance with ASTM D6913. Soil samples were oven dried to a constant weight and sorted by a number of different sized sieves. The amount of material retained on each sieve is measured and the percent of material passing each sieve is computed. The test results are presented as particle size distribution curves on Figure B-1.

3. ATTERBERG LIMITS

Five samples were tested to evaluate Atterberg limits in general accordance with ASTM D4318. The liquid limit (LL) and plastic limit (PL) of tested samples were evaluated. The difference between the liquid limit and the plastic limit is the plasticity index (PI) and represents the range of water content over which the soil behaves in a plastic state. The term NP refers to non-plastic and the term NV refers to no value. Test results are presented on the test pit logs in Appendix A and on Figure B-2.

4. R-VALUE

Two tests were performed on selected soil samples to evaluate subgrade resistance to wheel loads. Testing was performed in general accordance with ASTM D2844. The R-Value of a material is obtained when the material is in a state of saturation such that water will be exuded from the compacted test specimen when a 300-psi load is applied. Test results are presented on Figures B-3 and B-4

5. SWELL/COLLAPSE POTENTIAL

Two tests were performed on soil samples in general accordance with ASTM D4546. The swell/collapse potential of the selected samples was determined by applying incremental one-dimensional loads to the sample up to a specified load, and then wetting the sample. The displacement of the sample after wetting at the specified load is recorded and used to calculate the swell or collapse potential as a percent. The test results are presented on Figures B-5 and B-6.

6. CHEMICAL TESTS

Three tests were performed on selected soil samples to determine the contents of soluble sulfate, total soluble solids (i.e. solubility), and soluble soil chlorides. The tests were performed by Silver State Analytical, Inc. The results of the tests are shown on Figure B-7 through B-9.

CLIENT Pedcor, LLC

PROJECT NAME Chocolate Drive

PROJECT NUMBER R20215772E1

PROJECT LOCATION Sun Valley, Nevada

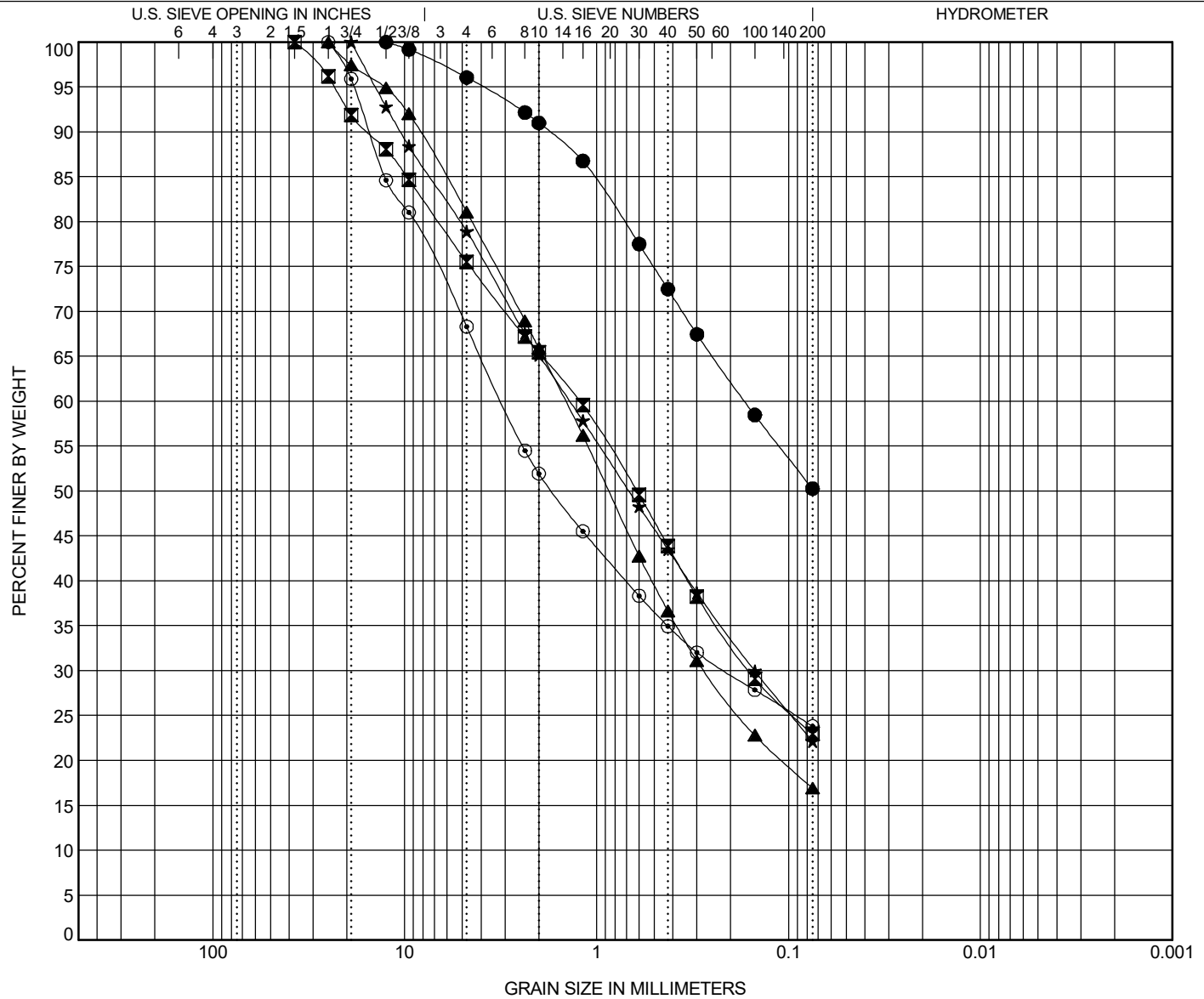

COBBLES	GRAVEL		SAND			SILT OR CLAY
	coarse	fine	coarse	medium	fine	

Location	Classification						LL	PL	PI	
● TP-1 8.0'	SANDY FAT CLAY (CH)						51	28	23	
☒ TP-3 5.0'	SILTY SAND with GRAVEL (SM)						46	33	13	
▲ TP-5 6.0'	SILTY SAND with GRAVEL (SM)						NP	NP	NP	
★ TP-6 5.0'	SILTY SAND with GRAVEL (SM)						25	22	3	
◎ TP-7 11.0'	SILTY SAND with GRAVEL (SM)						43	34	9	
Location	D100	D60	D30	D10	Cc	Cu	%Gravel	%Sand	%Silt	%Clay
● TP-1 8.0'	12.5	0.169	--	--	--	--	3.9	45.8	50.3	
☒ TP-3 5.0'	37.5	1.225	--	--	--	--	24.5	52.6	23.0	
▲ TP-5 6.0'	25	1.45	--	--	--	--	18.9	64.2	16.9	
★ TP-6 5.0'	19	1.379	--	--	--	--	21.1	56.8	22.1	
◎ TP-7 11.0'	25	3.118	--	--	--	--	31.7	44.5	23.8	

SIEVE - GES, CM, STD, GDT - 1/10/22 12:44 - J:\GES\CLIENTS\RENO OFFICE\PROJECTS\2021\R20215772E1\R20215772E1.GPJ

R-VALUE TEST REPORT

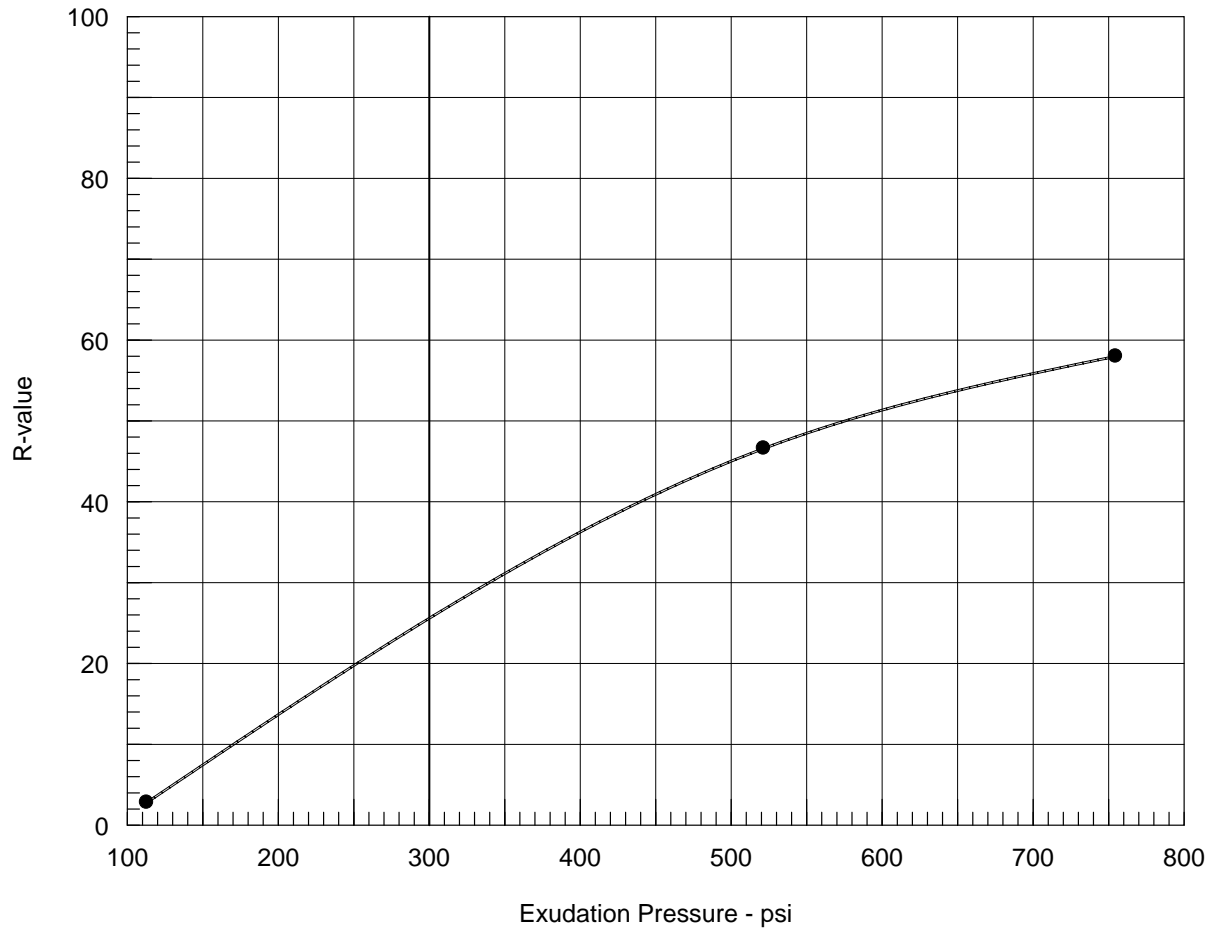

Resistance R-Value and Expansion Pressure - ASTM D2844

No.	Compact. Pressure psi	Density pcf	Moist. %	Expansion Pressure psi	Horizontal Press. psi @ 160 psi	Sample Height in.	Exud. Pressure psi	R Value	R Value Corr.
1	350	98.7	24.1	0.00	59	2.50	755	58	58
2	350	93.8	25.1	0.00	74	2.50	522	47	47
3	110	101.5	33.0	0.00	149	2.70	113	3	3

Test Results	Material Description
R-value at 300 psi exudation pressure = 26	Silty sand with gravel
Project No.: R20215772E1 Project: CHOCOLATE DDRIVE Location: TP-3 @ 5.0'-7.0' Sample Number: TP-3 Depth: 5.0'-7.0' Date: 12/23/2021	Tested by: C. Byer Checked by: S. Solares Remarks:



Figure B-3

R-VALUE TEST REPORT

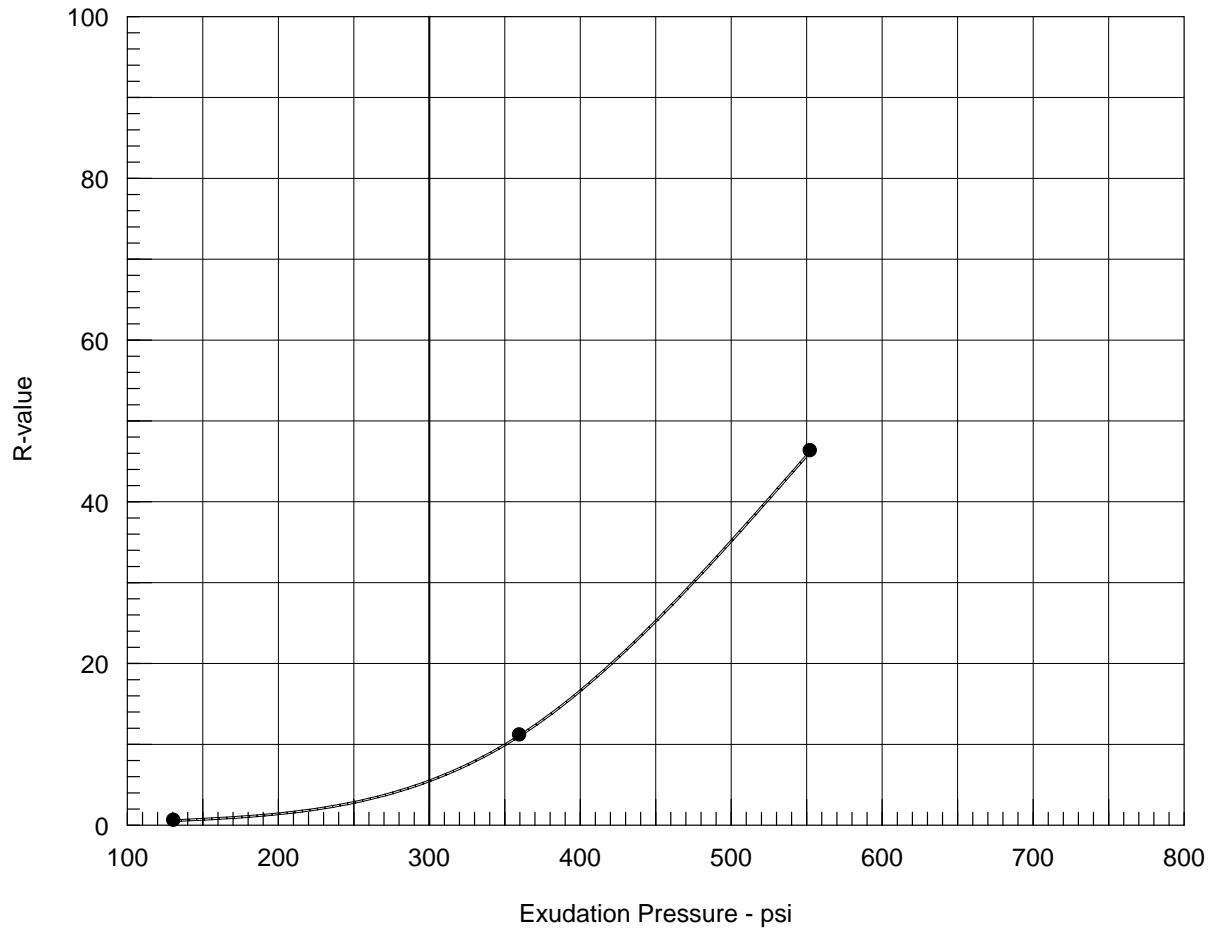

Resistance R-Value and Expansion Pressure - ASTM D2844

No.	Compact. Pressure psi	Density pcf	Moist. %	Expansion Pressure psi	Horizontal Press. psi @ 160 psi	Sample Height in.	Exud. Pressure psi	R Value	R Value Corr.
1	110	111.4	18.4	0.00	158	2.70	131	1	1
2	240	116.2	16.6	0.00	130	2.60	360	10	11
3	350	117.4	14.7	0.00	75	2.50	553	46	46

Test Results	Material Description
--------------	----------------------

R-value at 300 psi exudation pressure = 5

Silty sand with gravel

Project No.: R20215772E1
Project: CHOCOLATE DRIVE
Location: TP-6 @ 5.0'-7.0'
Sample Number: TP-6 **Depth:** 5.0'-7.0'
Date: 12/23/2021

Tested by: C. Byer
Checked by: S. Solares
Remarks:



Figure B-4

Swell/Collapse

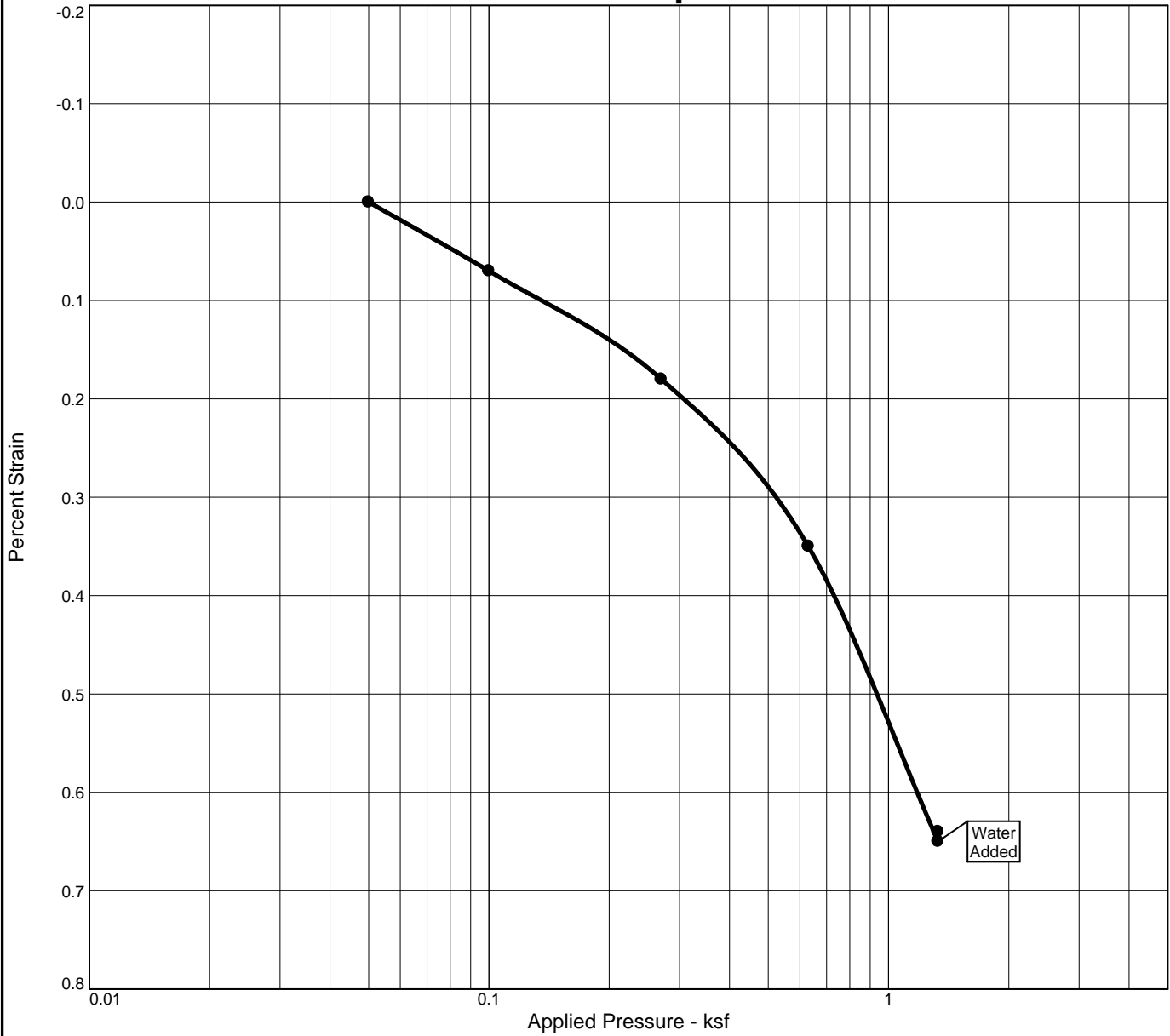

Natural		Dry Dens. (pcf)	LL	PI	Sp. Gr.	USCS	AASHTO	
Saturation	Moisture							
58.7 %	12.1 %	105.5	46	13	2.60	SM	A-2-7(0)	

MATERIAL DESCRIPTION

Silty sand with gravel

Project No. R20215772E1 Project: CHOCOLATE DRIVE	Client: PEDCOR INVESTMENT	Location: TP-3 @ 5.0'-7.0' Depth: 5.0'-7.0'	Sample Number: TP-3
GEOTECHNICAL & ENVIRONMENTAL SERVICES, INC.			

Remarks:

Figure B-5

Tested By: A. SANDERS _____

Swell/Collapse

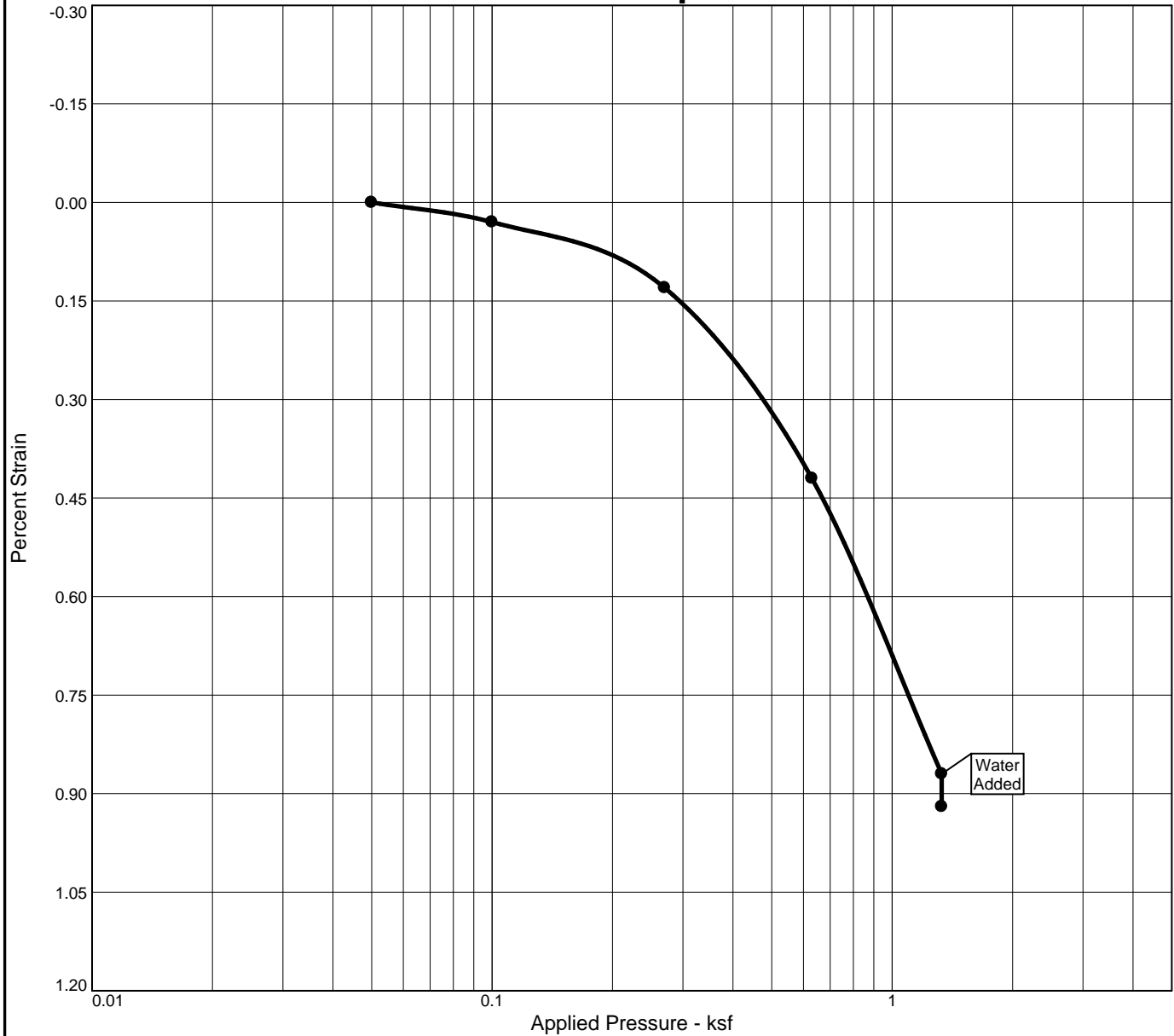

Natural		Dry Dens. (pcf)	LL	PI	Sp. Gr.	USCS	AASHTO	
Saturation	Moisture							
66.3 %	12.1 %	111.5	NV	NP	2.65	SM	A-1-b	

MATERIAL DESCRIPTION

Silty sand with gravel

Project No. R20215772E1 **Client:** PEDCOR INVESTMENT
Project: CHOCOLATE DRIVE
Location: TP-5 @ 6.0'-7.0' **Depth:** 6.0'-7.0' **Sample Number:** TP-5

Remarks:



Figure B-6

Tested By: A. SANDERS _____



Silver State Labs-Las Vegas
 3626 E. Sunset Road, Suite 100
 Las Vegas, NV 89120
 (702) 873-4478 FAX: (702) 873-7967
 www.ssalabs.com

Analytical Report

WO#: 21120907
 Date Reported: 12/17/2021

CLIENT: GES **Collection Date:**
Project: R20215772
Lab ID: 21120907-01 **Matrix:** SOIL
Client Sample ID 21-177 TP-3 @ 5'-7'

Analyses	Result	RL	Qual	Units	DF	Date Analyzed
SOIL 4. SULFATE, SOLUBILITY & CHLORIDE CHLORIDE - SOILS						Analyst: LJ
Chloride	ND	50		mg/Kg	5	12/17/2021 9:28:00 AM
SOIL 4. SULFATE, SOLUBILITY & CHLORIDE WATER SOLUBLE SULFATE (SO4)						Analyst: LJ
Sulfate	0.160	0.0100		%	1	12/17/2021 9:26:00 AM
SOIL 4. SULFATE, SOLUBILITY & CHLORIDE TOTAL SALTS (SOLUBILITY)						Analyst: LJ
Solubility	0.730	0.0100		%	1	12/17/2021 9:24:00 AM

Qualifiers: DF Dilution Factor. H Holding times for preparation or analysis exceeded.
 (Qual) MCL Maximum Contaminant Level. ND Not Detected at the PQL.
 PQL Practical Quantitation Limit.



Silver State Labs-Las Vegas
 3626 E. Sunset Road, Suite 100
 Las Vegas, NV 89120
 (702) 873-4478 FAX: (702) 873-7967
 www.ssalabs.com

Analytical Report

WO#: 21120960
 Date Reported: 12/20/2021

CLIENT: GES **Collection Date:**
Project: R20215772
Lab ID: 21120960-01 **Matrix:** SOIL
Client Sample ID 21-177 TP-5 @ 6'-7'

Analyses	Result	RL	Qual	Units	DF	Date Analyzed
SOIL 4. SULFATE, SOLUBILITY & CHLORIDE CHLORIDE - SOILS						Analyst: LJ
Chloride	89	50		mg/Kg	5	12/20/2021 11:18:00 AM
SOIL 4. SULFATE, SOLUBILITY & CHLORIDE WATER SOLUBLE SULFATE (SO4)						Analyst: LJ
Sulfate	0.0400	0.0100		%	1	12/20/2021 2:20:00 PM
SOIL 4. SULFATE, SOLUBILITY & CHLORIDE TOTAL SALTS (SOLUBILITY)						Analyst: LJ
Solubility	0.0400	0.0100		%	1	12/20/2021 9:10:00 AM

**Qualifiers:
(Qual)**

DF Dilution Factor.
 MCL Maximum Contaminant Level.
 PQL Practical Quantitation Limit.

H Holding times for preparation or analysis exceeded.
 ND Not Detected at the PQL.



Silver State Labs-Las Vegas
 3626 E. Sunset Road, Suite 100
 Las Vegas, NV 89120
 (702) 873-4478 FAX: (702) 873-7967
 www.ssalabs.com

Analytical Report

WO#: 21120907
 Date Reported: 12/17/2021

CLIENT: GES **Collection Date:**
Project: R20215772
Lab ID: 21120907-02 **Matrix:** SOIL
Client Sample ID 21-177 TP-6 @ 5'-7'

Analyses	Result	RL	Qual	Units	DF	Date Analyzed
SOIL 4. SULFATE, SOLUBILITY & CHLORIDE CHLORIDE - SOILS						Analyst: LJ
Chloride	ND	50		mg/Kg	5	12/17/2021 9:28:00 AM
SOIL 4. SULFATE, SOLUBILITY & CHLORIDE WATER SOLUBLE SULFATE (SO4)						Analyst: LJ
Sulfate	ND	0.0100		%	1	12/17/2021 9:26:00 AM
SOIL 4. SULFATE, SOLUBILITY & CHLORIDE TOTAL SALTS (SOLUBILITY)						Analyst: LJ
Solubility	0.0500	0.0100		%	1	12/17/2021 9:24:00 AM

**Qualifiers:
(Qual)**

DF Dilution Factor.
 MCL Maximum Contaminant Level.
 PQL Practical Quantitation Limit.

H Holding times for preparation or analysis exceeded.
 ND Not Detected at the PQL.



APPENDIX C – DESIGN FIGURES

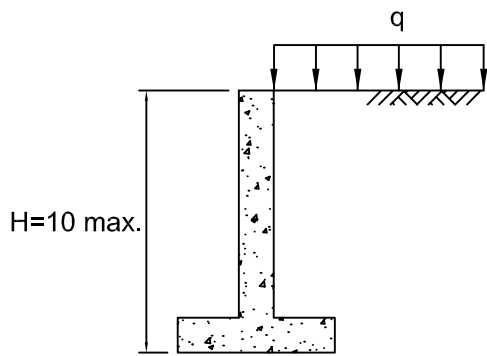

Static Earth Pressure

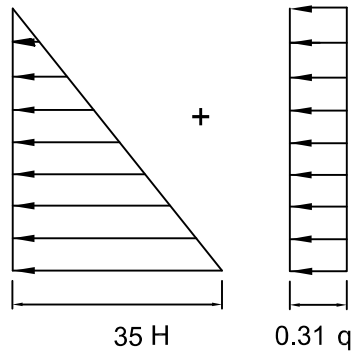

Seismic Earth Pressure

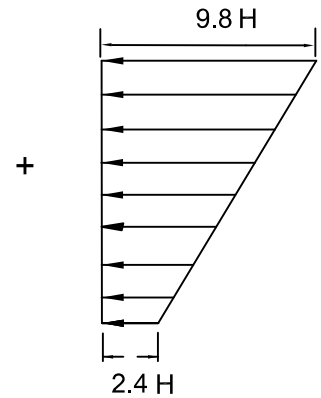

Active Condition

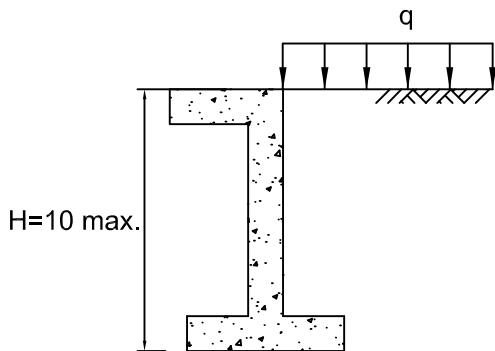

Static Earth Pressure

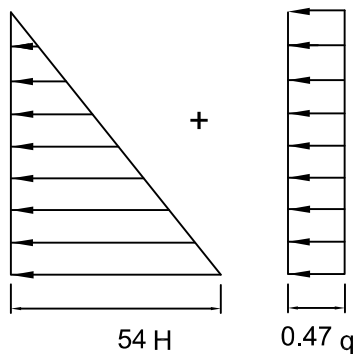

Seismic Earth Pressure

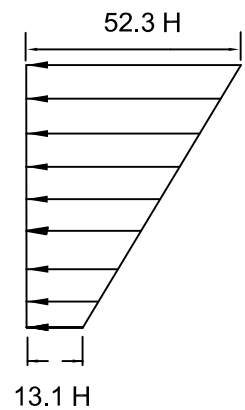

At-Rest Condition

Notes:

- H is height of wall in feet.
- q is magnitude of uniform surcharge load in pounds per square foot (psf).
- Earth pressures are in psf.
- Earth pressures shown assume that no hydrostatic pressure is exerted on the wall.

NOT TO SCALE



GEOTECHNICAL & ENVIRONMENTAL SERVICES, INC.
 (702) 365-1001
 7150 Placid Street
 Las Vegas, NV 89119
 www.gesnevada.com

LATERAL EARTH PRESSURE DIAGRAM

6400 CHOCOLATE DRIVE
 MULTI-FAMILY RESIDENCES
 SUN VALLEY, NEVADA

DRAWN BY:
 TM

REVIEWED BY:
 SS

DATE DRAWN:
 1/6/2021

PROJECT NO.
 R20215772E1

FIGURE NO.
 C-1