

Administrative Permit Application **Gerlach Geothermal Exploration Project**

Submitted to Washoe County
November 8, 2022

ORIGINAL

Prepared for

ORNI 26, LLC
6140 Plumas Street
Reno, NV 89519

Prepared by



WOOD RODGERS

BUILDING RELATIONSHIPS ONE PROJECT AT A TIME

1361 Corporate Blvd • Reno, NV 89502 • Tel: 775.823.4068 • www.woodrogers.com

Table of Contents

Section 1

- ❖ Washoe County Development Application
 - Owner Affidavit
 - Proof of Property Tax

Section 2

- ❖ Project Description
 - Executive Summary
 - Background
 - Washoe County Master Plan and Zoning
 - Project Request
 - Project Description
 - Grading
 - Traffic and Parking
 - Landscaping
 - Viewshed Analysis
- ❖ Administrative Permit Findings

Section 3

- ❖ Maps
 - Vicinity Map
 - Aerial Map
 - Master Plan Map
 - Zoning Map
 - Proposed Well Locations
 - Photo Simulations
 - Reduced Civil Plans

Section 4

- ❖ BLM Decision Record
- ❖ Findings of No Significant Impacts (FONSI)
- ❖ Ormat Operations Plan

Map Pocket

- ❖ Site Plans (full size)

Section 1

Washoe County Development Application

Your entire application is a public record. If you have a concern about releasing personal information, please contact Planning and Building staff at 775.328.6100.

Project Information		Staff Assigned Case No.: _____	
Project Name: Gerlach Geothermal Exploration Project			
Project Description: The proposed project includes an Administrative Permit to allow drilling and testing of up to 13 geothermal exploration wells and associated access road construction.			
Project Address: 0 State Route 447 & 0 State Route 34			
Project Area (acres or square feet): ~28,475 acres (project area limited to 51.5 acres)			
Project Location (with point of reference to major cross streets AND area locator): The project is located within four parcels in the vicinity of Gerlach with all exploration wells accessible via Highways 447 and 34.			
Assessor's Parcel No.(s):	Parcel Acreage:	Assessor's Parcel No.(s):	Parcel Acreage:
071-150-09	28,166	071-220-19	36.3
071-220-18	168.8	071-220-23	98.0
Indicate any previous Washoe County approvals associated with this application: Case No.(s).			
Applicant Information (attach additional sheets if necessary)			
Property Owner:		Professional Consultant:	
Name: Bureau of Land Management		Name: Wood Rodgers, Inc	
Address: 5100 E. Winnemucca Blvd		Address: 1361 Corporate Blvd	
Winnemucca, Nevada	Zip: 89445	Reno, Nevada	Zip: 89502
Phone:	Fax:	Phone: 775-823-5258	Fax:
Email: mehall@blm.gov		Email: shuggins@woodrodgers.com	
Cell:	Other:	Cell: 775-250-8213	Other:
Contact Person: Mark Hall		Contact Person: Stacie Huggins	
Applicant/Developer:		Other Persons to be Contacted:	
Name: ORNI 26, LLC		Name:	
Address: 6140 Plumas Street		Address:	
Reno, Nevada	Zip: 89519		Zip:
Phone: 775-356-9029	Fax:	Phone:	Fax:
Email: KCarter@ORMAT.com		Email:	
Cell:	Other:	Cell:	Other:
Contact Person: Kim Carter		Contact Person:	
For Office Use Only			
Date Received:	Initial:	Planning Area:	
County Commission District:		Master Plan Designation(s):	
CAB(s):		Regulatory Zoning(s):	

**Administrative Permit Application
Supplemental Information**

(All required information may be separately attached)

1. What is the type of project or use being requested?

Geothermal Exploration Wells

2. What section of the Washoe County code requires the Administrative permit required?

Section 110.328.15

3. What currently developed portions of the property or existing structures are going to be used with this permit?

The parcels are primarily undeveloped with the exception of some existing dirt roads, which may be used to access the well pads where feasible.

4. What improvements (e.g. new structures, roadway improvements, utilities, sanitation, water supply, drainage, parking, signs, etc.) will have to be constructed or installed and what is the projected time frame for the completion of each?

Improvements/grading will be limited to no more than 13 well pads and access roads in accordance with the approved EA from BLM. Applicant anticipates beginning construction of the first well pad in Q4 2022.

5. Is there a phasing schedule for the construction and completion of the project?

N/A

6. What physical characteristics of your location and/or premises are especially suited to deal with the impacts and the intensity of your proposed use?

The various well pad sites are located in areas away from existing development in order to minimize impacts to private property owners. Refer to Maps in Section 3 of this application.

7. What are the anticipated beneficial aspects or effect your project will have on adjacent properties and the community?

Data from the exploration wells will be used to determine if there is a viable commercial geothermal resource in the area.

8. What will you do to minimize the anticipated negative impacts or effect your project will have on adjacent properties?

To reduce impacts associated with noise or dust, exploration wells will be drilled and evaluated one at a time with adjustments to subsequent well locations based on information obtained during the drilling of each well. Refer to Project Description in Section 2 and/or FONSI from BLM for additional information.

9. Please describe any operational parameters and/or voluntary conditions of approval to be imposed on the administrative permit to address community impacts.

Revegetate disturbed areas in accordance with WC and BLM standards.

10. How many improved parking spaces, both on-site and off-site, are available or will be provided? (Please indicate on site plan.)

Given the type and temporary nature of the proposed use, no permanent parking spaces are anticipated to be needed.

11. What types of landscaping (e.g. shrubs, trees, fencing, painting scheme, etc.) are proposed? (Please indicate location on site plan.)

N/A. Providing landscaping will only call attention to the well pads. Refer to Project Description for additional explanation

12. What type of signs and lighting will be provided? On a separate sheet, show a depiction (height, width, construction materials, colors, illumination methods, lighting intensity, base landscaping, etc.) of each sign and the typical lighting standards. (Please indicate location of signs and lights on site plan.)

N/A

13. Are there any restrictive covenants, recorded conditions, or deed restrictions (CC&Rs) that apply to the area subject to the administrative permit request? (If so, please attach a copy.)

Yes No

14. Utilities:

a. Sewer Service	N/A
b. Water Service	N/A

For most uses, the Washoe County Code, Chapter 110, Article 422, Water and Sewer Resource Requirements, requires the dedication of water rights to Washoe County. Please indicate the type and quantity of water rights you have available should dedication be required:

c. Permit #		acre-feet per year	
d. Certificate #		acre-feet per year	
e. Surface Claim #		acre-feet per year	
f. Other, #		acre-feet per year	

Title of those rights (as filed with the State Engineer in the Division of Water Resources of the Department of Conservation and Natural Resources):

Section 2

PROJECT DESCRIPTION

Executive Summary

Commission District #: 5, Jeanne Herman
Applicant: ORNI 26, LLC
APN Numbers: 071-150-09, 071-220-18, 19, and 23

Request: A request has been made for Administrative Permit to:
1) allow for geothermal exploration wells per Article 328

Location: The project area is located northwest of Gerlach near State Highway 447 and State Highway 34 in the High Desert Planning Area.

Background

The Applicant is proposing to construct, operate and maintain a Geothermal Exploration Project on parcels located near the town of Gerlach, Nevada. The project, as planned, will include drilling and testing of up to 13 geothermal wells and construction of access roads. The wells proposed as part of the Project are located within federal geothermal leases on public lands managed by the BLM.

The applicant previously submitted an Operations Plan (OP) (*refer to Section 4 of this submittal packet*) to the BLM. In addition, an Environmental Assessment has been prepared to analyze the environmental impacts of the project by the BLM. On October 21, 2022, the BLM issued the Final EA, Decision Record and Findings of No Significant Impacts (FONSI). A copy of the Decision Record and FONSI have been included in Section 4 of this packet. The Final EA can be downloaded or reviewed here: <https://eplanning.blm.gov/eplanning-ui/project/2016744/570>

Washoe County Master Plan and Zoning

The project area spans 4 parcels within Washoe County totaling approximately 28,000 acres; however, the specific Area of Interest (AOI) is limited to approximately 2,724 acres. The entire project area has a master plan designation of Rural (R) and a zoning designation of General Rural (GR) and is located within the High Desert Area Plan (*Refer to Vicinity Map, Site Aerial, Existing Master Plan Map, and Existing Zoning Map in Section 3 of this submittal packet*).

Project Request

Included with this application is an Administrative Permit to allow for geothermal exploration wells in accordance with Section 110.328.15 of the Washoe County Development Code. The project will include up to 13 geothermal exploration wells and associated roads to access well sites. It is worth noting that per Washoe County Code Section 110.438.35 (b)(1) grading associated with the wells and roads does not require a special use permit since the Administrative Permit requires a hearing process and review pursuant to which mitigation conditions may be attached in the same manner as in the special use permit process.

Project Description

The applicant is proposing up to 13 exploration wells, all located on public lands managed by the BLM in the AOI (*refer to Proposed Well Locations Exhibit in Section 3*). Geothermal exploration wells would typically be drilled and evaluated one at a time with adjustments to subsequent well locations based on additional information obtaining during the drilling of each well. Only those drill pads scheduled to be drilled will be cleared.

As designed, the project anticipates temporary surface disturbance for up to 13 well pads all located on public lands administered by the BLM. Each well pad would be 2.1 acres per pad or 39.9 acres in total (13 well pads * 2.1

Gerlach Geothermal Exploration Project

Administrative Permit – Project Description

acres/pad). Well pads will be approximately 300 feet by 300 feet but actual dimensions could be modified to match physical and environmental characteristics of each site and minimize disturbance where possible. Once drilling is complete, the shoulders of the pad will be reclaimed, however, the majority of the pad would be kept clear for ongoing operations and/or the potential to redrill the well.

Wells will be drilled at depths of approximately 1,500 to 7,500 feet, though target depths could change pending the results of well flow testing. Directional drilling could be used to intercept geothermal targets but where directional drilling is used, the down hole position of the well will not be allowed to extend outside of the lease area. As noted in the EA, well casing depth would be no less than 200 feet below ground to prevent commingling of geothermal fluids and underground aquifers.

In terms of water use, well drilling could require as much as 35,000 gallons per day. Water for grading, compaction and dust control would be as much as 6,000 gallons per day, most likely during the first 2 months of construction. As noted in the BLM EA, water for these activities would be supplied from one or more shallow water wells drilled from one or more of the proposed drill sites (as approved by BLM), a private ranch source, or as a bulk water purchase from the Gerlach GID (pending availability).

In terms of employees, during construction of the well pads, there could be up to 10 workers at each active drill site for the duration of the well drilling, approximately 45 days. Personnel will sleep in a self-contained portable trailer on the active drill site while the well is being drilled. This is needed to ensure safety of the equipment and the well pad site as well as to gather data about the well site. Exploration drilling activities require a 24-hour operation and supervision to ensure a safe drilling environment at all times and to allow for immediate action during drilling activities and for the safety of the drill rig personnel.

Grading

Grading activities include well pads, improvements to existing roads or ground clearing for new roads. As noted previously, only pads scheduled to be drilled will be graded. For the purposes of overall potential project impact, if all pads and roads were graded, approximately 32 acres would be disturbed with approximately 237,910 CY of cut and 156,870 CY of fill. In terms of each site, each well site will include a level pad for the drill rig and a graded surface for the support equipment. Where sites are located on steeper slopes, cuts and fills have been minimized to reduce visual impacts from the surrounding areas.

Specifically, well pad preparation activities will include clearing, earthwork, drainage and other improvements necessary for efficient and safe operation and for fire prevention. Only those pads scheduled to be drilled will be cleared. As much as possible, native materials (derived from grading to balance cut and fill) will be used for site and road building materials.

In addition to the drill rig, each pad will include a reserve pit to contain and temporarily store stormwater runoff, geothermal fluid during well testing, drilling cuttings, and circulating drilling mud. The reserve pits would be fenced on three sides during drilling. Once drilling is complete, the fourth side will be fenced to prevent access by people, wildlife and/or livestock. Fencing will be built according to rangeland management specifications and remain in place until reserve pit reclamation begins. To further prevent people, wildlife and/or livestock from accessing the reserve pits, walls on one side of the reserve pit will be sloped at an approximate 30 percent incline.

Other grading activities include new roads and/or improvements to existing roads providing access to the well pads. Where feasible, existing roads (aka "two tracks") will be used to access well pads, however, even existing roads will require an additional 10 feet width of surface disturbance for road improvements. Where new roads are necessary, they will require a 20' wide surface in order to accommodate a 15' wide drivable roadbed. As proposed, the total

Gerlach Geothermal Exploration Project

Administrative Permit – Project Description

maximum area of surface disturbance required for all access roads, assuming a 15' wide roadbed, would be approximately 4.4 acres. It is worth noting that all roads will be constructed pursuant to BLM design criteria.

Traffic and Parking

Minimal traffic is anticipated once operations are complete. A majority of the traffic will occur during construction of the well pads. A temporary drilling crew of approximately 10 workers will be at the active drill site for the duration of the well drilling (approximately 45 days). The drilling crew, consisting primarily of Ormat staff and contractors, will travel to the Project site daily for exploration activities. To minimize dust, the access roads will be covered with up to 4 inches of gravel to create an all-weather surface and prevent rut formation.

Once complete, the project is estimated to generate approximately 20 (10 workers*2/day) weekday peak hour trips, well below the thresholds required to provide a traffic analysis. Furthermore, since the site is primarily utilizing existing roads, and since the area is so remote, any impacts are anticipated to be minimal.

As a part of the project, the Applicant is requesting a waiver to eliminate requirements associated with parking and maneuvering areas being paved. The applicant is requesting that this requirement be waived since paved parking is generally intended for the urban environment and the location of the well pads is very remote and does not include services like storm water utilities including curb and gutter which are generally included with the installation of pavement.

Landscaping

The proposed project does not include any formal landscaping and the applicant is requesting to waive all of the provisions of Article 412 given the temporary nature of the exploration well pads. This is proposed in an attempt to support the Character Management Area of the High Desert as outlined in the High Desert Area Plan, specifically Goal 2 which states:

“All landscape designs will emphasize the use of native and low water requirement vegetation, with non-native and atypical vegetation integrated sparingly into any landscaped area.”

Following this goal, rather than providing landscaping, the applicant would prefer to keep the area looking natural and undisturbed. Efforts in grading when clearing the land, including preserving the topsoil, will help to ensure the success of re-establishing the native vegetation after it has been disturbed by grading processes. No formal landscaping is proposed as it will not reflect the character of the High Desert Planning Area. It is also worth noting that the Applicant will be required to comply with BLM requirements to reclaim disturbed sites to the pre-disturbed condition, which would be counter-intuitive to providing landscaping.

As a part of the project, the Applicant is requesting that the requirements associated with landscaping and screening be waived to help the project meet the Character Statement outlined in the High Desert Area Plan. Several policies, including Policy HD.16.5 encourage the use of native drought tolerant plants to be used in the landscape. Proposing formal landscaping including trees and screening shrubs in accordance with Section 110.412 would have a negative visual impact on the area and take away from the character of the area since the native vegetation does not include plant types typically found in more formal landscaping, including the use of trees. While no formal landscaping is proposed, the applicant will meet Washoe County (and BLM) standards for revegetation and stabilization of disturbed areas.

Viewshed Analysis

As noted previously, the project area is located in northern Washoe Valley, approximately 1 mile northwest of Gerlach. Given the existing topography of the area and the known astrotourism in the area, the Applicant has prepared photo simulations to show daytime and nighttime impacts on the area (*refer to Section 3 for Day and Night*

Gerlach Geothermal Exploration Project

Administrative Permit – Project Description

Photo simulations). It is worth noting that the nighttime photo simulations provided were originally prepared to support the BLM's review of the project.

Specifically, a Night Sky Baseline Report was prepared in March 2022 to look at existing light sources in and near the study area and was used to determine the extent of any changes future development related to the Project might have to the existing night sky conditions. Using baseline photos taken during full moon and new moon phases, the BLM identified three (3) well pads within the AOI for photo simulations with the purpose of simulating the anticipated additional light from a single operational drill rig at proposed well pads within the project area. Based on the existing light sources in and near Gerlach, including temporary economic events occurring in the area, the drill rig and associated equipment lighting, the analysis determined that while the project would introduce new, temporary localized source of light to the project area, it would be visible mostly in the distance and would be largely indistinguishable from the existing lights in Gerlach, or it would be far enough in the distance to not interfere with night sky viewing (BLM 2022).

To further support the night sky analysis, the applicant prepared photo simulations using daytime photos that include the drill rig on the same three (3) well pads analyzed by BLM. For comparison purposes, daytime and nighttime photos have been included with this application for the specific well pad sites.

It is worth noting that during nighttime drilling, the drill rig and associated equipment will include lighting with shields to direct light down to the ground while illuminating the structure and providing worker safety. As appropriate, lighting will comply with Dark Skies standards to reflect away from adjoining properties to minimize off-site glare in accordance with the High Desert Area Plan.

Gerlach Geothermal Exploration Project
Administrative Permit – Project Description

Administrative Permit Findings

Prior to approving an application for an Administrative Permit, the Planning Commission, Board of Adjustment or a hearing examiner shall find that all of the following are true:

(a) Consistency. The proposed use is consistent with the action programs, policies, standards and maps of the Master Plan and the applicable area plan;

Response: The project area is designated as Rural and in accordance with Washoe County Development Code, exploration/test wells are an allowed use through the approval of an administrative permit. The proposed project has been designed to meet goals and policies within the area plan; specifically, goal fourteen which states that Washoe County will support development of geothermal energy production.

(b) Improvements. Adequate utilities, roadway improvements, sanitation, water supply, drainage, and other necessary facilities have been provided, the proposed improvements are properly related to existing and proposed roadways, and an adequate public facilities determination has been made in accordance with Division Seven;

Response: Access to the proposed well pad sites will utilize existing roads where feasible, however, new roads may also be necessary. As proposed, there is approximately 3 miles of roads with a total disturbance estimated to be 4.4 acres which accounts for a 20' wide road section with 15' drivable roadbed. Given the type and temporary nature of project proposed, no utility services are anticipated.

(c) Site Suitability. The site is physically suitable for the type of development and for the intensity of development;

Response: As previously stated, the project area is located in an area that has been previously identified as an appropriate area of geothermal activity including active geothermal leases with the BLM, therefore suggesting it is physically suitable for this type of development (i.e. – exploration wells). In terms of topography, the proposed well pads are located in areas that are relatively flat and with slopes generally less than 30%. It is worth noting that if all pads and roads (as approved by the BLM) were graded, the project would disturb approximately 32 acres with approximately 80,000 CY of exported material.

(d) Issuance Not Detrimental. Issuance of the permit will not be significantly detrimental to the public health, safety or welfare; injurious to the property or improvements of adjacent properties; or detrimental to the character of the surrounding area; and

Response: The proposed project (up to 13 well pads for exploration purposes) will not be detrimental to the public health, safety or welfare or to the character of the surrounding area. As noted in this description, and as seen in the photo simulations, drill rig equipment is not visible from key observation points in and around the community of Gerlach.

It is also worth noting that on October 21, 2022, the BLM issued the Final EA, Decision Record and Finding of No Significant Impact (FONSI) for the project (*copies included in Section 4 of this application packet*).

(e) Effect on a Military Installation. Issuance of the permit will not have a detrimental effect on the location, purpose or mission of the military installation.

Response: N/A

Section 3

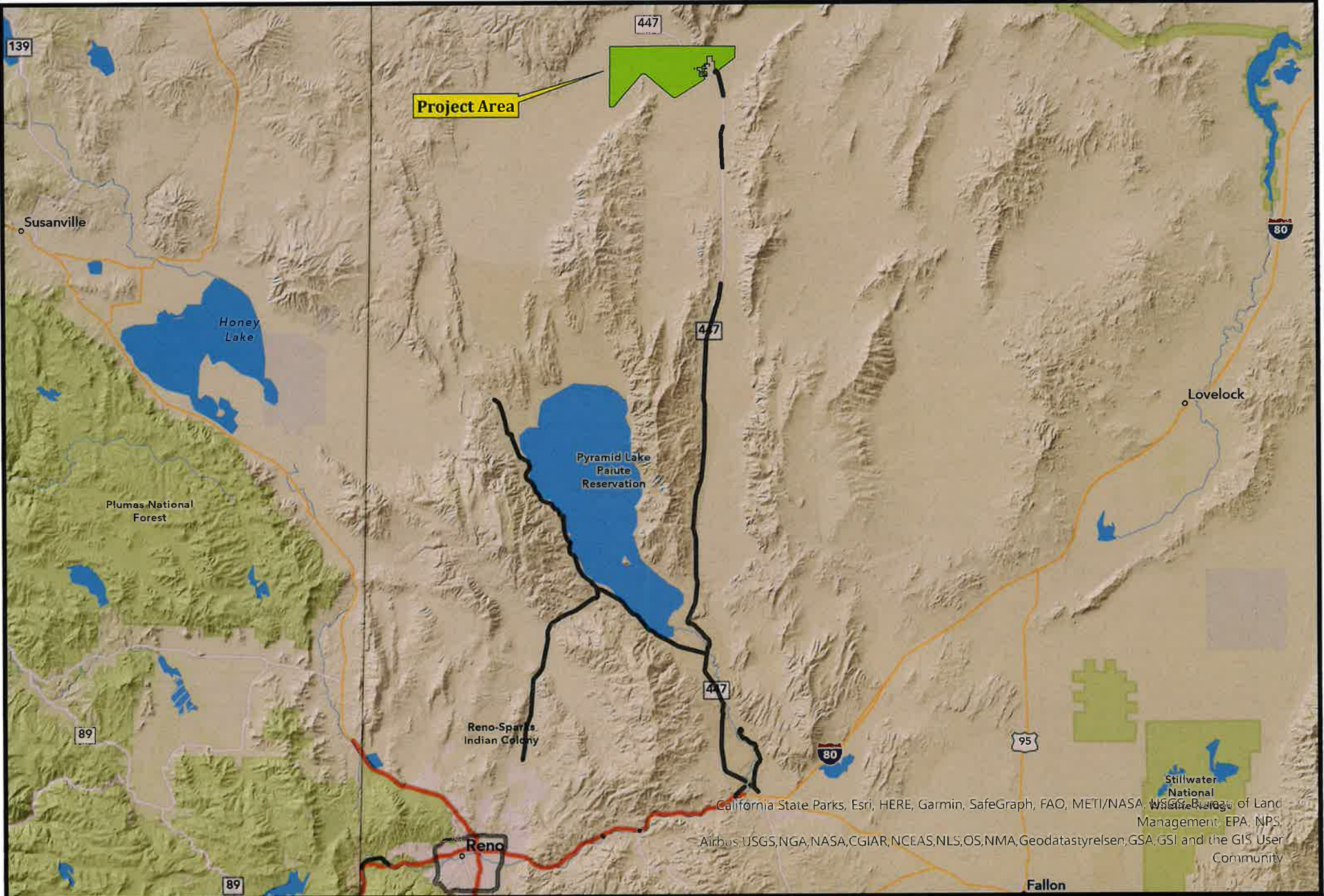

California State Parks, Esri, HERE, Garmin, SafeGraph, FAO, METI/NASA, USGS, Bureau of Land Management, EPA, NPS, Airbus, USGS, NGA, NASA, CGIAR, NCEAS, NLS, OS, NMA, Geodastyrelsen, GSA, GSI and the GIS User Community



Vicinity Map

Ormat Geothermal Well Exploration

 July 2022



WOOD RODGERS
 BUILDING RELATIONSHIPS ONE PROJECT AT A TIME
 1361 Corporate Boulevard
 Reno, NV 89502
 Tel: 775.823.4068
 Fax: 775.823.4068

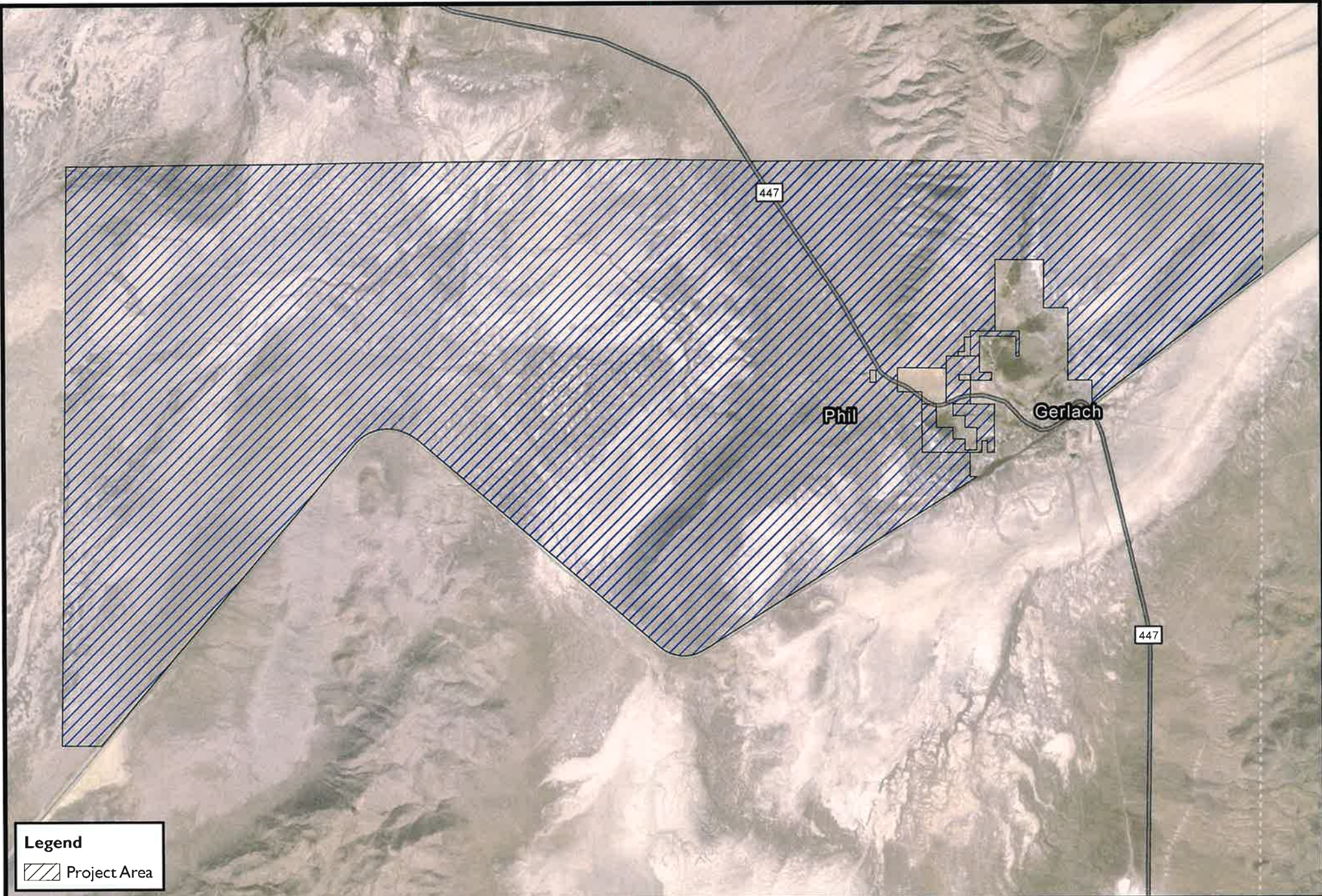

Legend

 Project Area



Aerial Map
Ormat Geothermal Well Exploration
July 2022



WOOD RODGERS
BUILDING RELATIONSHIPS ONE PROJECT AT A TIME
1361 Corporate Boulevard Tel: 775.823.4068
Reno, NV 89502 Fax: 775.823.4066

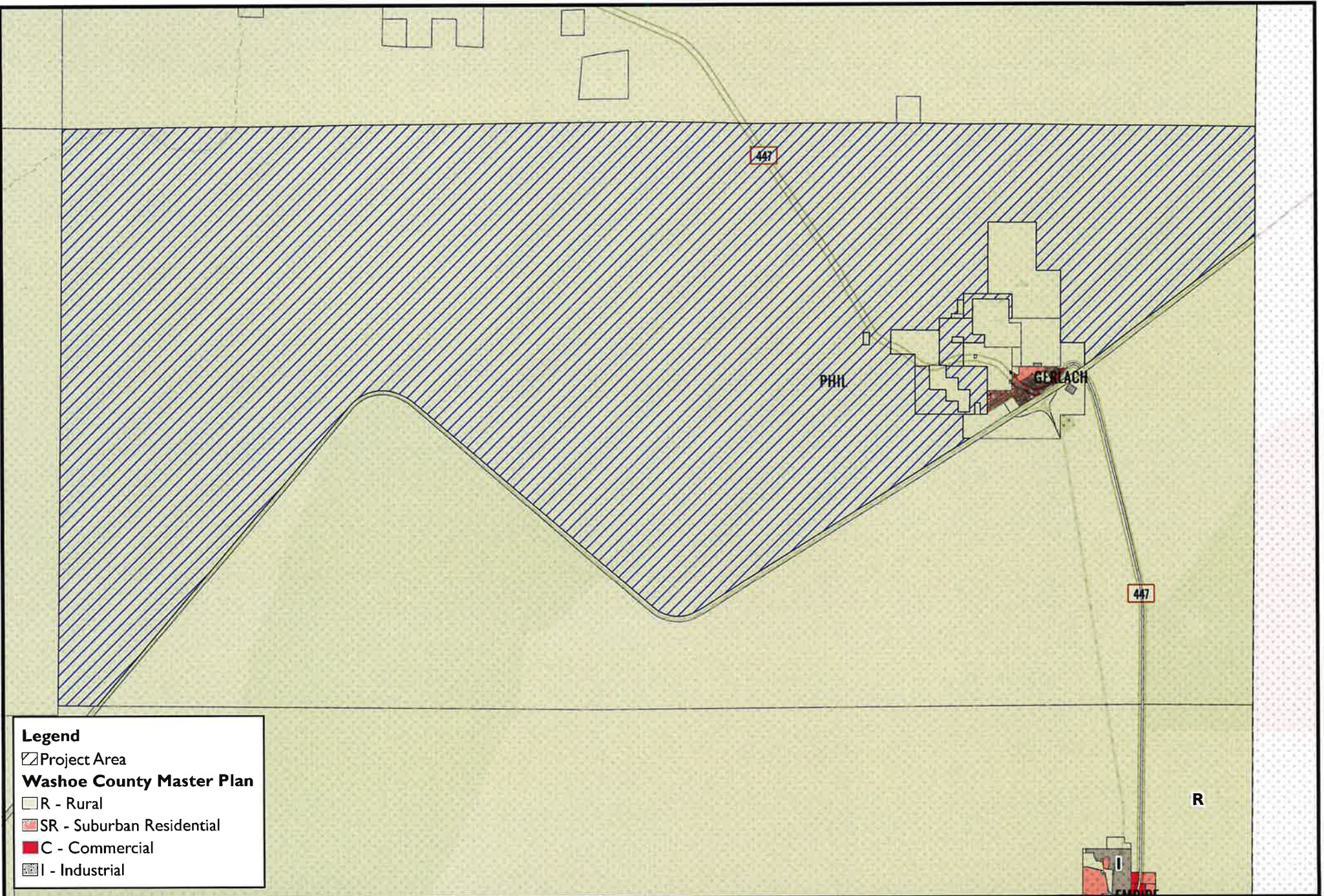

Legend

- Project Area
- Washoe County Master Plan**
- R - Rural
- SR - Suburban Residential
- C - Commercial
- I - Industrial

Master Plan
Ormat Geothermal Well Exploration
 July 2022

WOOD ROGERS
 BUILDING RELATIONSHIPS ONE PROJECT AT A TIME
 1361 Corporate Boulevard Tel: 775.823.4068
 Reno, NV 89502 Fax: 775.823.4066

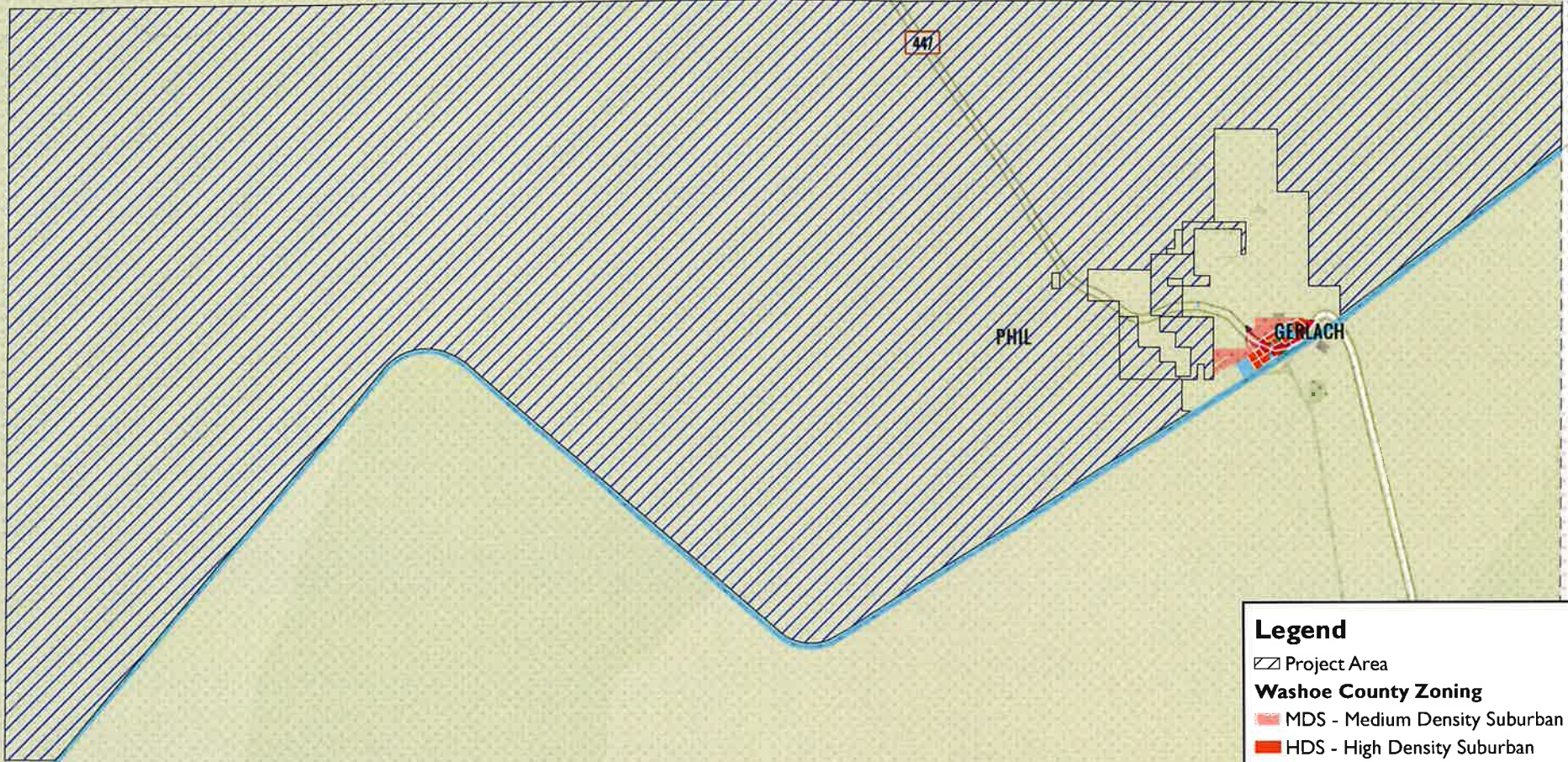

Legend

- Project Area
- Washoe County Zoning**
- MDS - Medium Density Suburban
- HDS - High Density Suburban
- GC - General Commercial
- TC - Tourist Commercial
- I - Industrial
- PSP - Public and Semi-Public Facilities
- PR - Parks and Recreation
- GR - General Rural



Zoning
Ormat Geothermal Well Exploration
 July 2022

WOOD RODGERS
 BUILDING RELATIONSHIPS ONE PROJECT AT A TIME
 1361 Corporate Boulevard Tel: 775.823.4068
 Reno, NV 89502 Fax: 775.823.4066

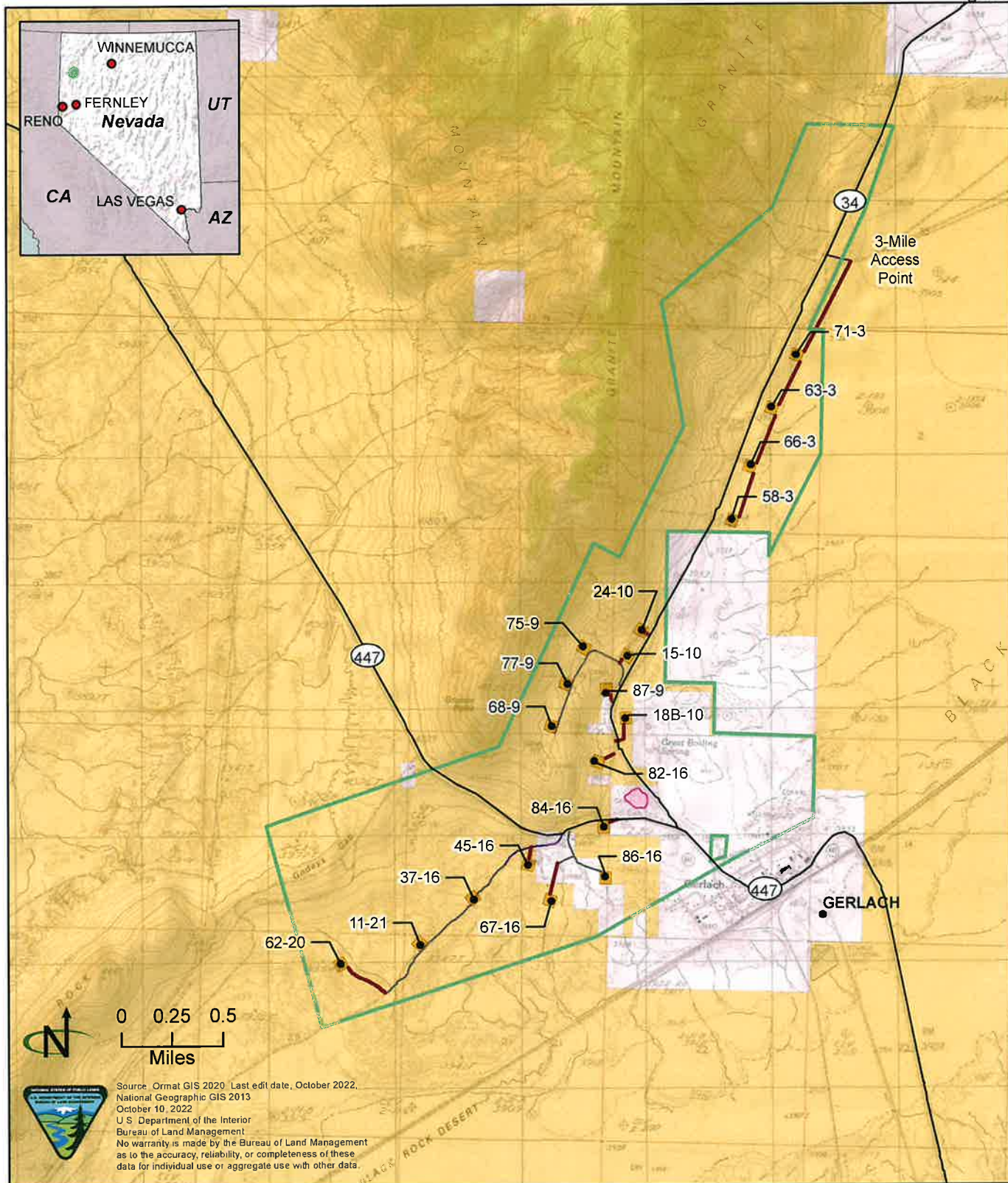
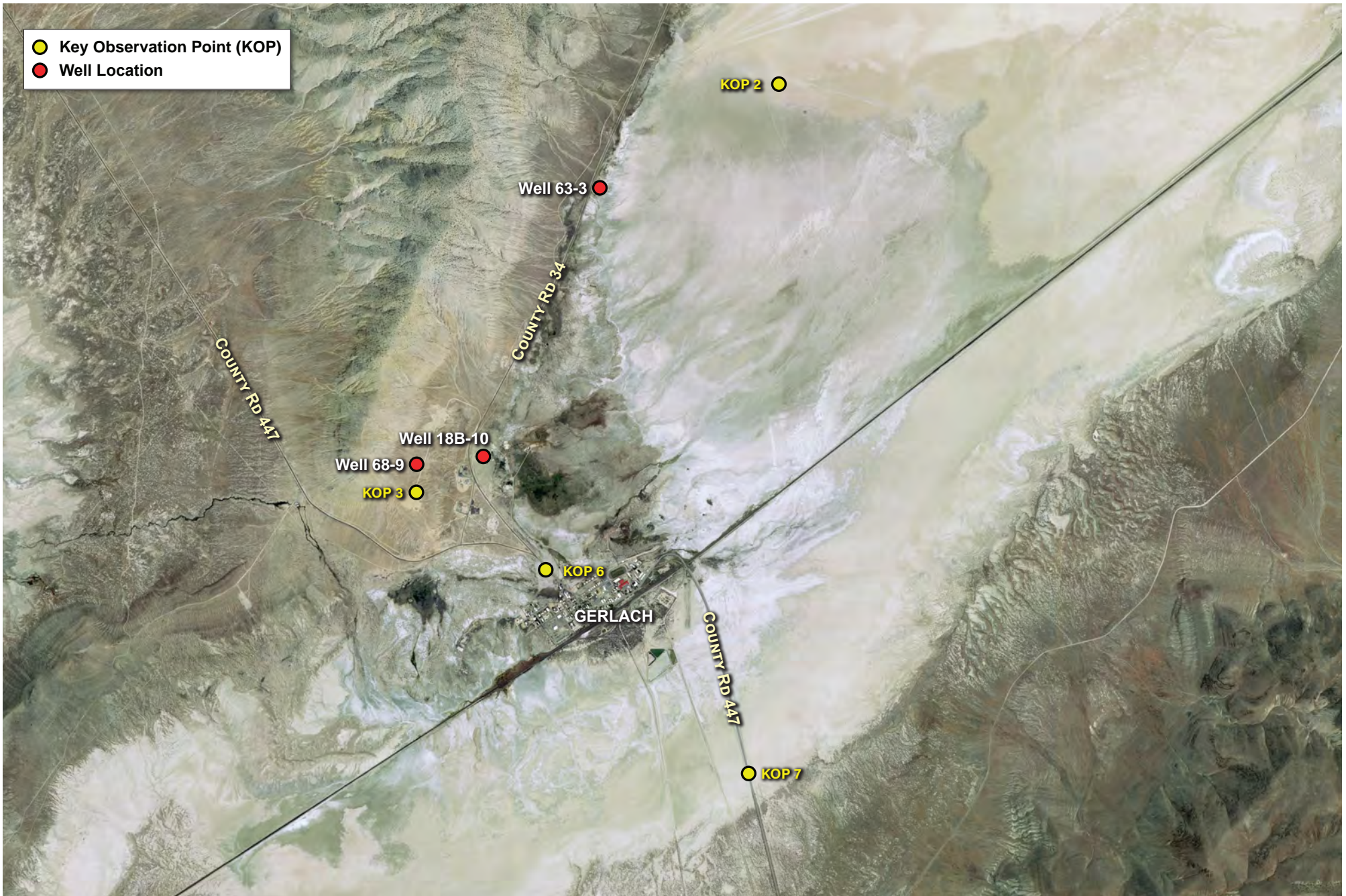

Figure A-4. 3-Mile Access Point (Alternative B)

- | | | |
|---|------------------------|----------------------------------|
| Gerlach geothermal AOI | Proposed access road | Surface Management Agency |
| Existing road | Proposed aggregate pit | Bureau of Land Management |
| Existing road, no improvements proposed | | Private |



Well and Key Observation Point Locations



KOP2: Existing Conditions



KOP2: Well Locations Within View

Note: Only one drill rig will be mobilized on site at a time



KOP2: Well 18B-10



KOP2: Well 18B-10, Night View

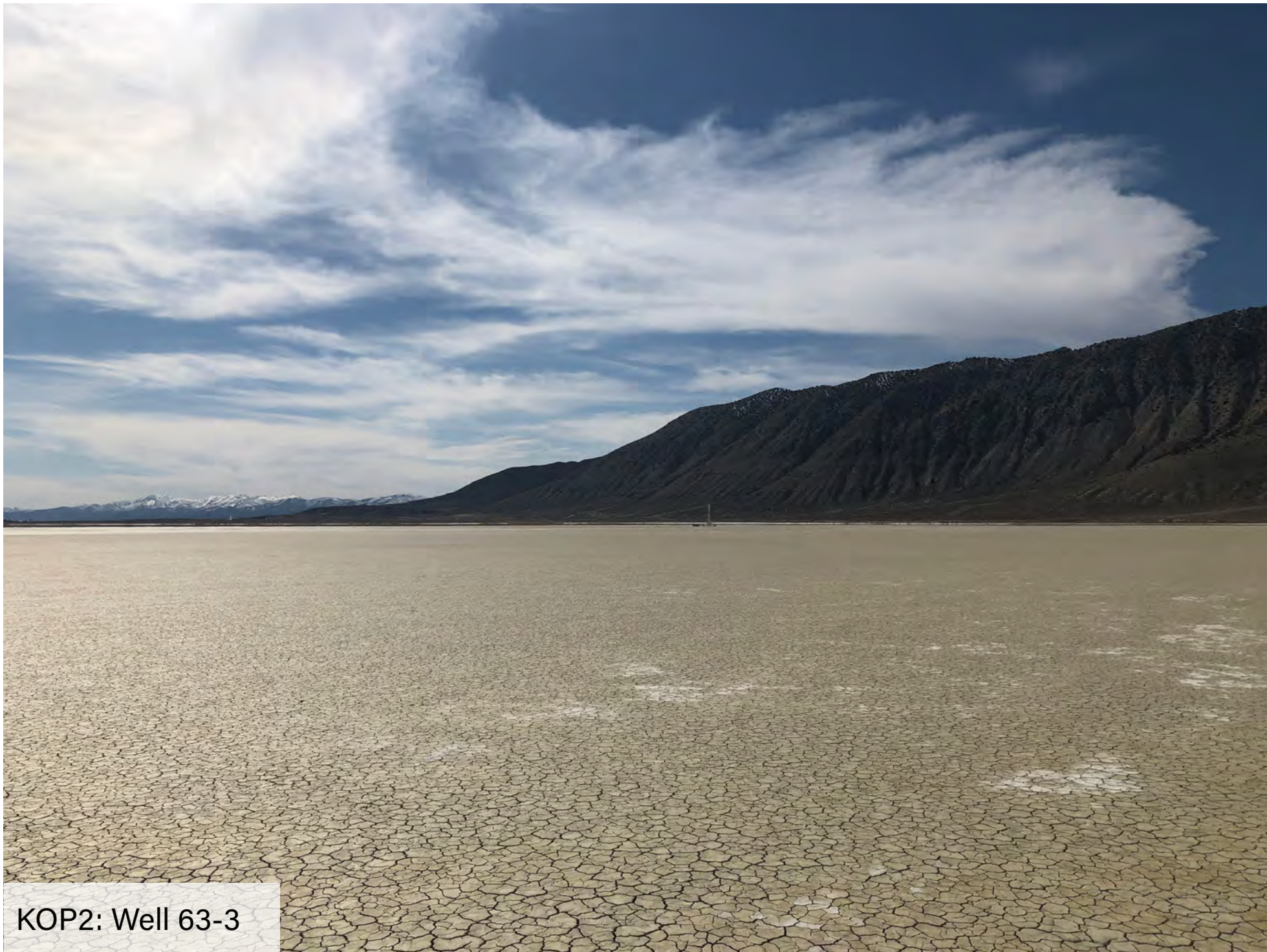

KOP2: Well 63-3



KOP2: Well 63-3, Night View

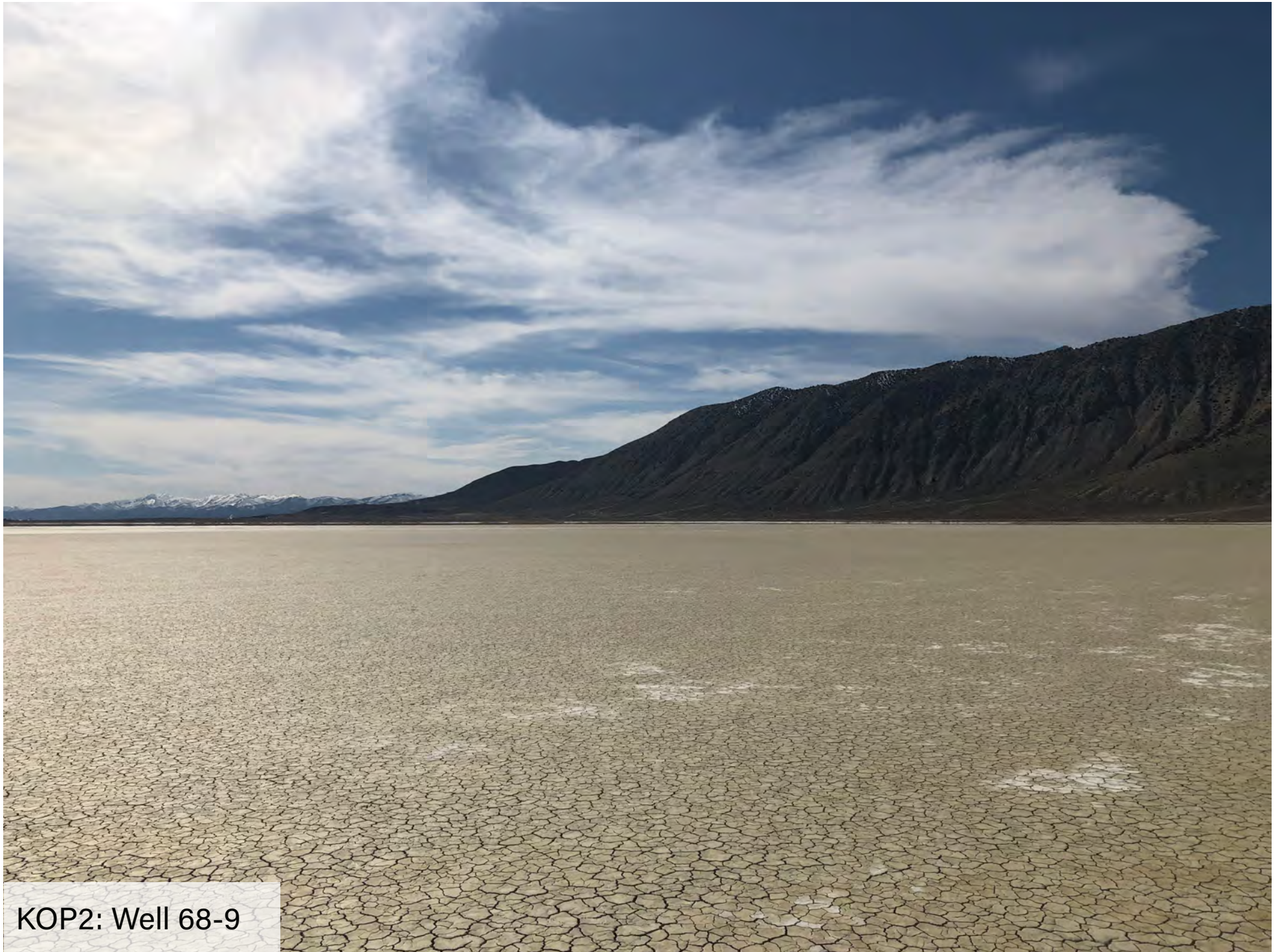

KOP2: Well 68-9



KOP2: Well 68-9, Night View



KOP3: Existing Conditions



Well 63-3

Well 18B-10

KOP3: Well Locations Within View

Note: Only one drill rig will be mobilized on site at a time



KOP3: Well 18B-10



KOP3: Well 18B-10, Night View

Note: Looking slightly left of daytime view



KOP3: Well 63-3



KOP3: Well 63-3, Night View

Note: Looking slightly left of daytime view



KOP6: Existing Conditions



Well 68-9

KOP6: Well Locations Within View

Note: Only one drill rig will be mobilized on site at a time. No night views available from this angle.



KOP6: Well 63-3, 3D Model Simulated View

Note: No daytime photos available from this view due to heavy smoke levels. An accurate simulated view was generated by utilizing Google Earth.



KOP6: Well 63-3, Night View

Note: Night photograph used for simulation



KOP7: Existing Conditions



Well 68-9

Well 18B-10

KOP7: Well Locations Within View

Note: Only one drill rig will be mobilized on site at a time



KOP7: Well 18B-10



KOP7: Well 18B-10, Night View



KOP7: Well 68-9



KOP7: Well 68-9, Night View

ORMAT GERLACH GEOTHERMAL WELL EXPLORATION

ADMINISTRATIVE PERMIT TITLE SHEET

OWNER/DEVELOPER:

ORNI 36 LLC
6140 PLUMAS ST.
RENO, NV 89519

BASIS OF BEARING:

NEVADA STATE PLANE COORDINATE SYSTEM, NEVADA WEST ZONE 2703, NORTH AMERICAN DATUM OF 1983 (NAD 1983 CONUS MOLODENSKY), AS DETERMINED USING REAL TIME KINEMATIC (RTK) GPS OBSERVATIONS WITH CALL DIMENSIONS SHOWN ARE GROUND DISTANCES, GRID TO GROUND COMBINED FACTOR = 1.000228852

BASIS OF ELEVATION:

U.S. GEOLOGICAL SURVEY, 2017, 1/3RD ARC-SECOND DIGITAL ELEVATION MODELS (DEMS) - USGS NATIONAL MAP 3DEP DOWNLOADABLE DATA COLLECTION: U.S. GEOLOGICAL SURVEY.

THIS IS A TILED COLLECTION OF THE 3D ELEVATION PROGRAM (3DEP) AND IS 1/3 ARC-SECOND (APPROXIMATELY 10 M) RESOLUTION. THE 3DEP DATA HOLDINGS SERVE AS THE ELEVATION LAYER OF THE NATIONAL MAP, AND PROVIDE FOUNDATIONAL ELEVATION INFORMATION FOR EARTH SCIENCE STUDIES AND MAPPING APPLICATIONS IN THE UNITED STATES. SCIENTISTS AND RESOURCE MANAGERS USE 3DEP DATA FOR HYDROLOGIC MODELING, RESOURCE MONITORING, MAPPING AND VISUALIZATION, AND MANY OTHER APPLICATIONS. THE ELEVATIONS IN THIS DEM REPRESENT THE TOPOGRAPHIC BARE-EARTH SURFACE. THE SEAMLESS 1/3 ARC-SECOND DEM LAYERS ARE DERIVED FROM DIVERSE SOURCE DATA THAT ARE PROCESSED TO A COMMON COORDINATE SYSTEM AND UNIT OF VERTICAL MEASURE. THESE DATA ARE DISTRIBUTED IN GEOGRAPHIC COORDINATES IN UNITS OF DECIMAL DEGREES, AND IN CONFORMANCE WITH THE NORTH AMERICAN DATUM OF 1983 (NAD 83). ALL ELEVATION VALUES ARE IN METERS AND, OVER THE CONTINENTAL UNITED STATES, ARE REFERENCED TO THE NORTH AMERICAN VERTICAL DATUM OF 1988 (NAVD88). THE SEAMLESS 1/3 ARC-SECOND DEM LAYER PROVIDES COVERAGE OF THE CONTIGUOUS UNITED STATES, HAWAII, PUERTO RICO, OTHER TERRITORIAL ISLANDS, AND IN LIMITED AREAS OF ALASKA. THE SEAMLESS 1/3 ARC-SECOND DEM IS AVAILABLE AS PRE-STAGED PRODUCTS TILED IN 1 DEGREE BLOCKS IN ERDAS .IMG, ESRI ARC-GRID, AND GRID FLOAT FORMATS. THE SEAMLESS 1/3 ARC-SECOND DEM LAYER IS UPDATED CONTINUALLY AS NEW DATA BECOME AVAILABLE. OTHER 3DEP PRODUCTS ARE NATIONALLY SEAMLESS DEMS IN RESOLUTIONS OF 1, AND 2 ARC SECONDS. THESE SEAMLESS DEMS WERE REFERRED TO AS THE NATIONAL ELEVATION DATASET (NED) FROM ABOUT 2000 THROUGH 2015 AT WHICH TIME THEY BECAME THE SEAMLESS DEM LAYERS UNDER THE 3DEP PROGRAM AND THE NED NAME AND SYSTEM WERE RETIRED. OTHER 3DEP PRODUCTS INCLUDE ONE-METER DEMS PRODUCED EXCLUSIVELY FROM HIGH RESOLUTION LIGHT DETECTION AND RANGING (LIDAR) SOURCE DATA AND FIVE-METER DEMS IN ALASKA AS WELL AS VARIOUS SOURCE DATASETS INCLUDING THE LIDAR POINT CLOUD AND INTERFEROMETRIC SYNTHETIC APERTURE RADAR (IFSAR) DIGITAL SURFACE MODELS AND INTENSITY IMAGES. ALL 3DEP PRODUCTS ARE PUBLIC DOMAIN.

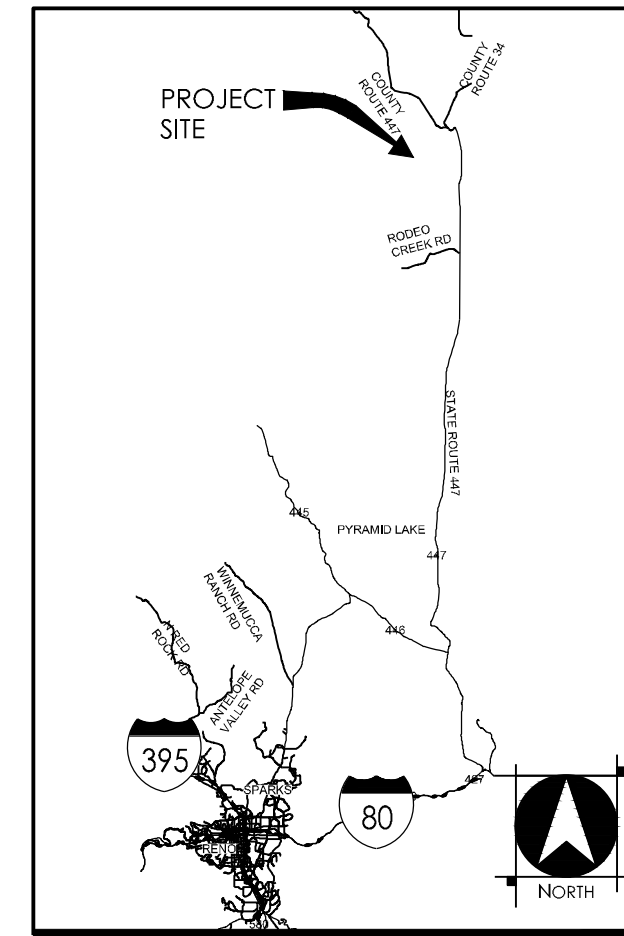

VICINITY MAP
NOT TO SCALE

SITE INFORMATION:

SITE PLAN STATISTICS:
AREA OF INTEREST: APPROXIMATELY 2,724 ACRES

PROJECT MAXIMUM SURFACE DISTURBANCE:
WELL PADS: APPROXIMATELY 27.5 ACRES
NEW ROADS: APPROXIMATELY 2.0 ACRES
EXISTING ROAD IMPROVEMENT: APPROXIMATELY 2.4 ACRES

PROJECT LOCATION:

ALL OR PORTIONS OF TOWNSHIP 32 NORTH, RANGE 23 EAST, SECTIONS 3, 4, 9, 10, 11, AND 13-21
ALL OR PORTIONS OF TOWNSHIP 33 NORTH, RANGE 23 EAST, SECTIONS 25 AND 31-36

WELL PAD AND NEW/IMPROVED ROADWAY EARTHWORK:

CUT - 237,910 CUBIC YARDS
FILL - 156,870 CUBIC YARDS

ENGINEERS STATEMENT:

I, TODD GAMMILL, DO HEREBY CERTIFY THAT THIS PLAN HAS BEEN PREPARED 8th DAY OF NOVEMBER 2022.

TODD GAMMILL, P.E. #13693

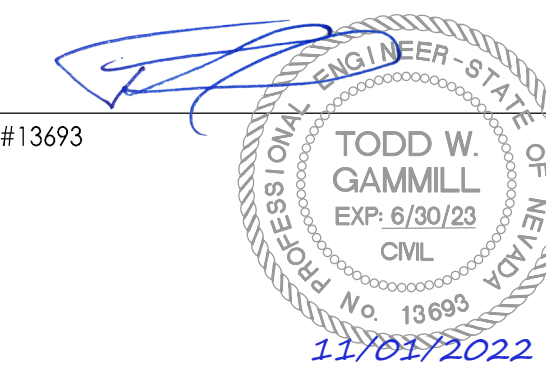

SHEET INDEX

SHT No.	DWG ID	DRAWING DESCRIPTION
1	T-1	TITLE SHEET
2	S-1	PRELIMINARY SITE PLAN
3	G-1	PRELIMINARY GRADING PLAN
4	G-2	PRELIMINARY GRADING PLAN
5	G-3	PRELIMINARY GRADING PLAN
6	G-4	PRELIMINARY GRADING PLAN
7	G-5	PRELIMINARY GRADING PLAN
8	G-6	PRELIMINARY GRADING PLAN
9	D-1	DETAIL SHEET

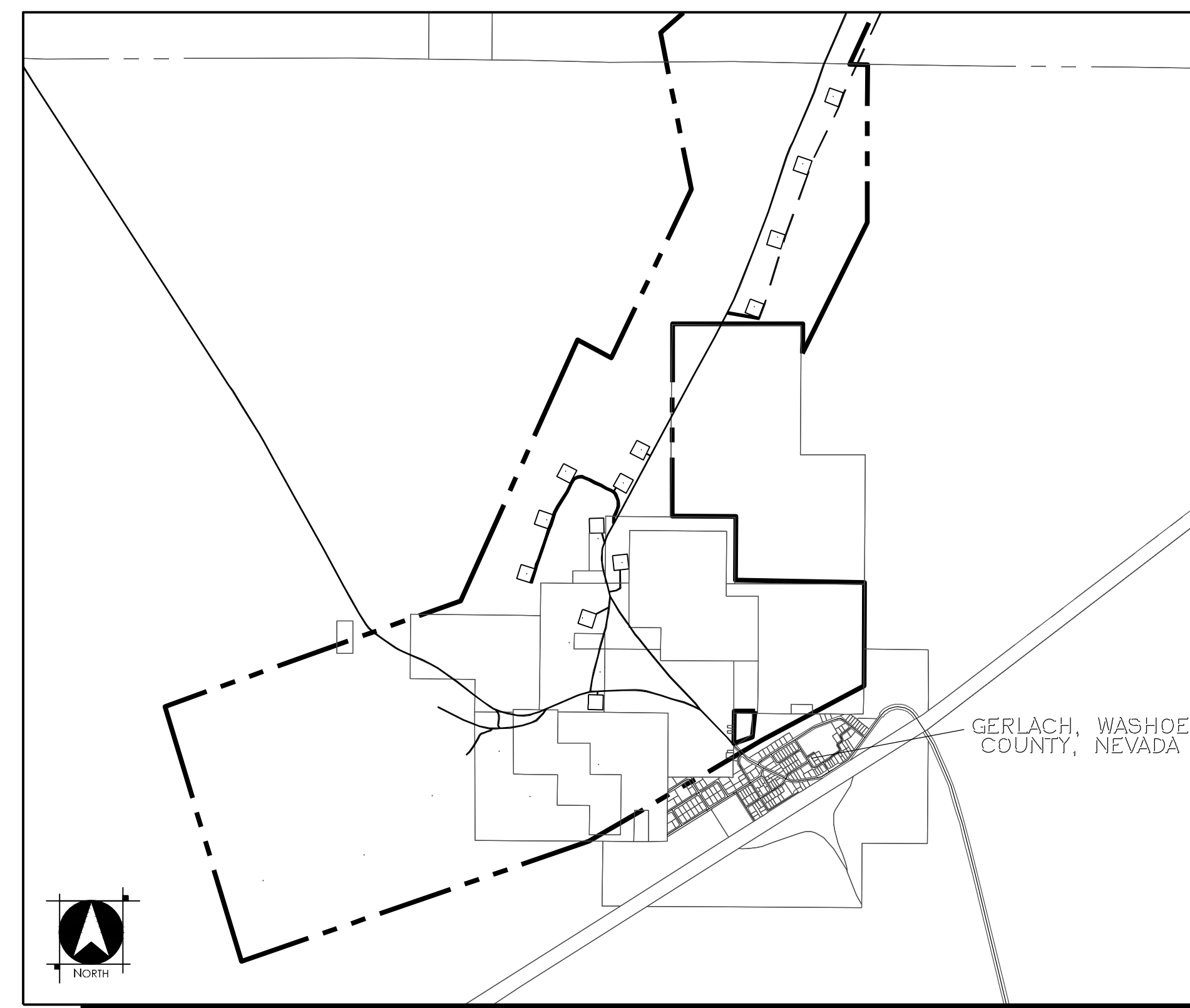

SITE PLAN
NOT TO SCALE

ORMAT GERLACH GEOTHERMAL WELL EXPLORATION TITLE SHEET

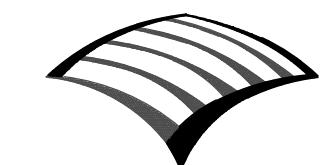

WOOD RODGERS
BUILDING RELATIONSHIPS ONE PROJECT AT A TIME

1361 Corporate Boulevard Tel 775.823.4068
Reno, NV 89502 Fax 775.823.4066

1707.019

NOVEMBER 2022





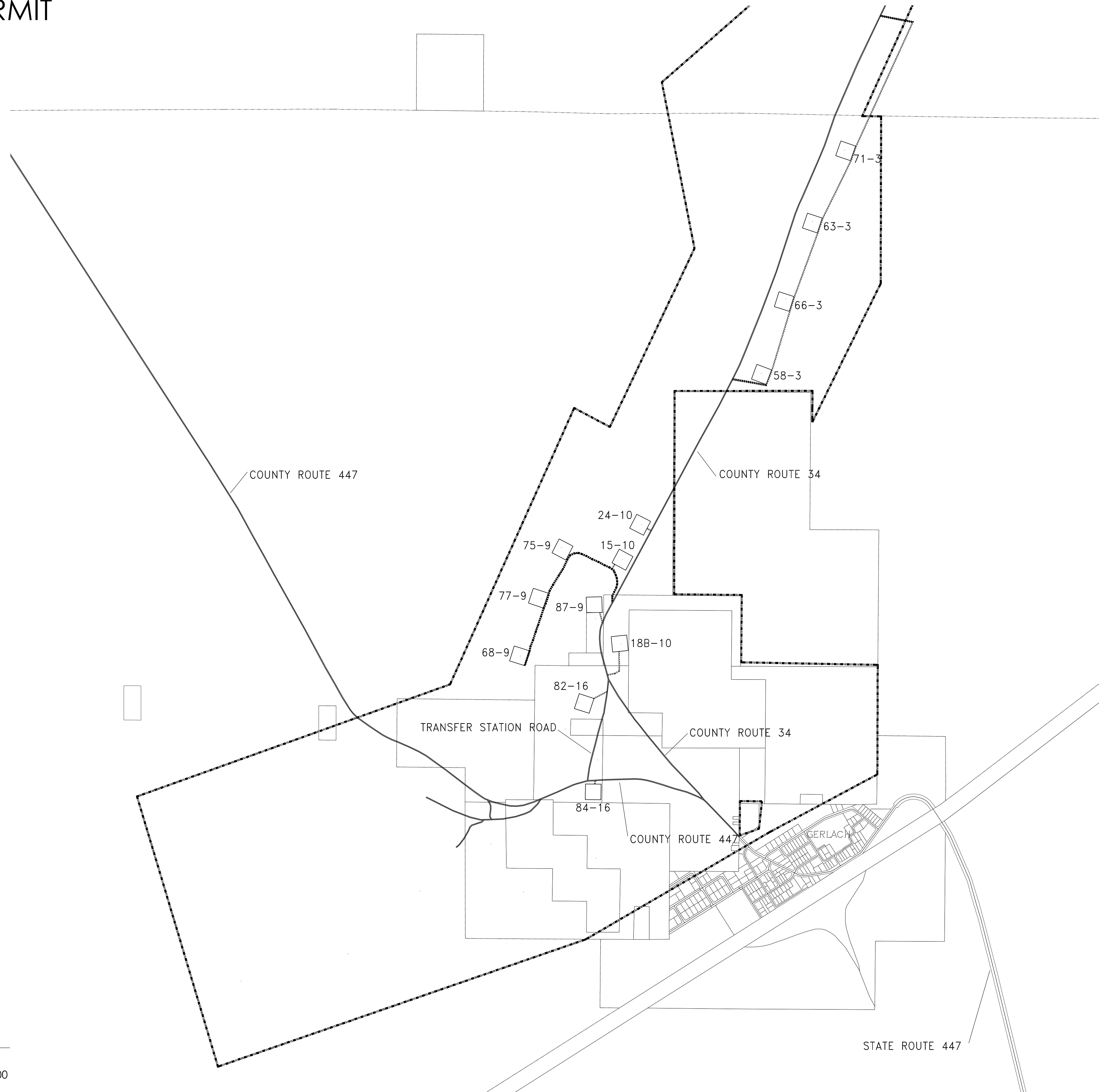

SHEET T-1 OF 9

ORMAT GERLACH GEOTHERMAL WELL EXPLORATION

ADMINISTRATIVE PERMIT SITE PLAN



LEGEND

-  PROJECT AREA
-  EX. DIRT ROAD TO BE IMPROVED
-  PROPOSED DIRT ROAD
-  EXISTING ROAD TO REMAIN/BE UTILIZED
-  XX-XX PAD NUMBER
-  EXISTING PARCEL LINE

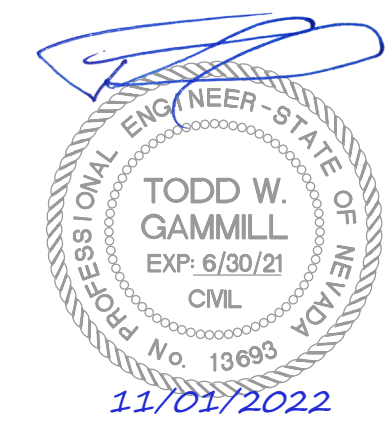
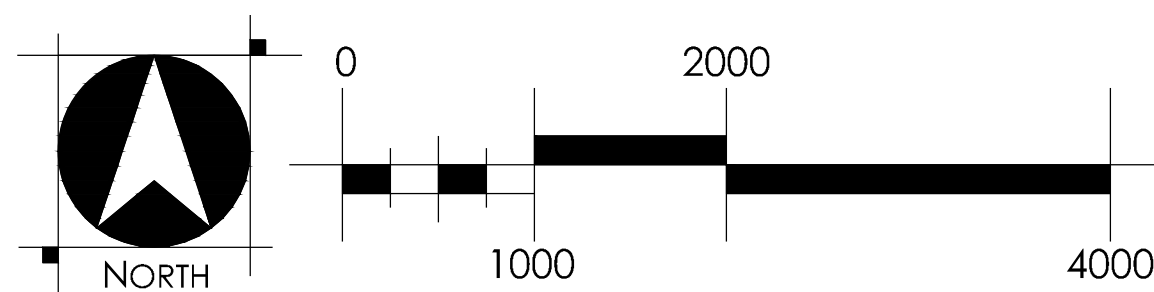

ORMAT GERLACH GEOTHERMAL WELL EXPLORATION SITE PLAN

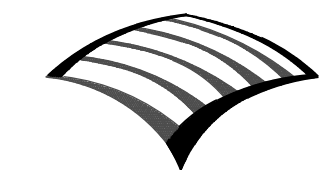

WOOD RODGERS
BUILDING RELATIONSHIPS ONE PROJECT AT A TIME

1361 Corporate Boulevard Tel 775.823.4068
Reno, NV 89502 Fax 775.823.4066

1707.019

NOVEMBER 2022

SHEET **S-1** OF 9

J:\Vabs\1707_Stemboat_Hills_Geothermal\019_Gerlach_Well_Explor_OA\Planning\Uwy\Administrative Permits\002_AP_GME_S01.dwg 11/1/2022 11:06 AM Todd Gamill

ORMAT GERLACH GEOTHERMAL WELL EXPLORATION

ADMINISTRATIVE PERMIT GRADING PLAN

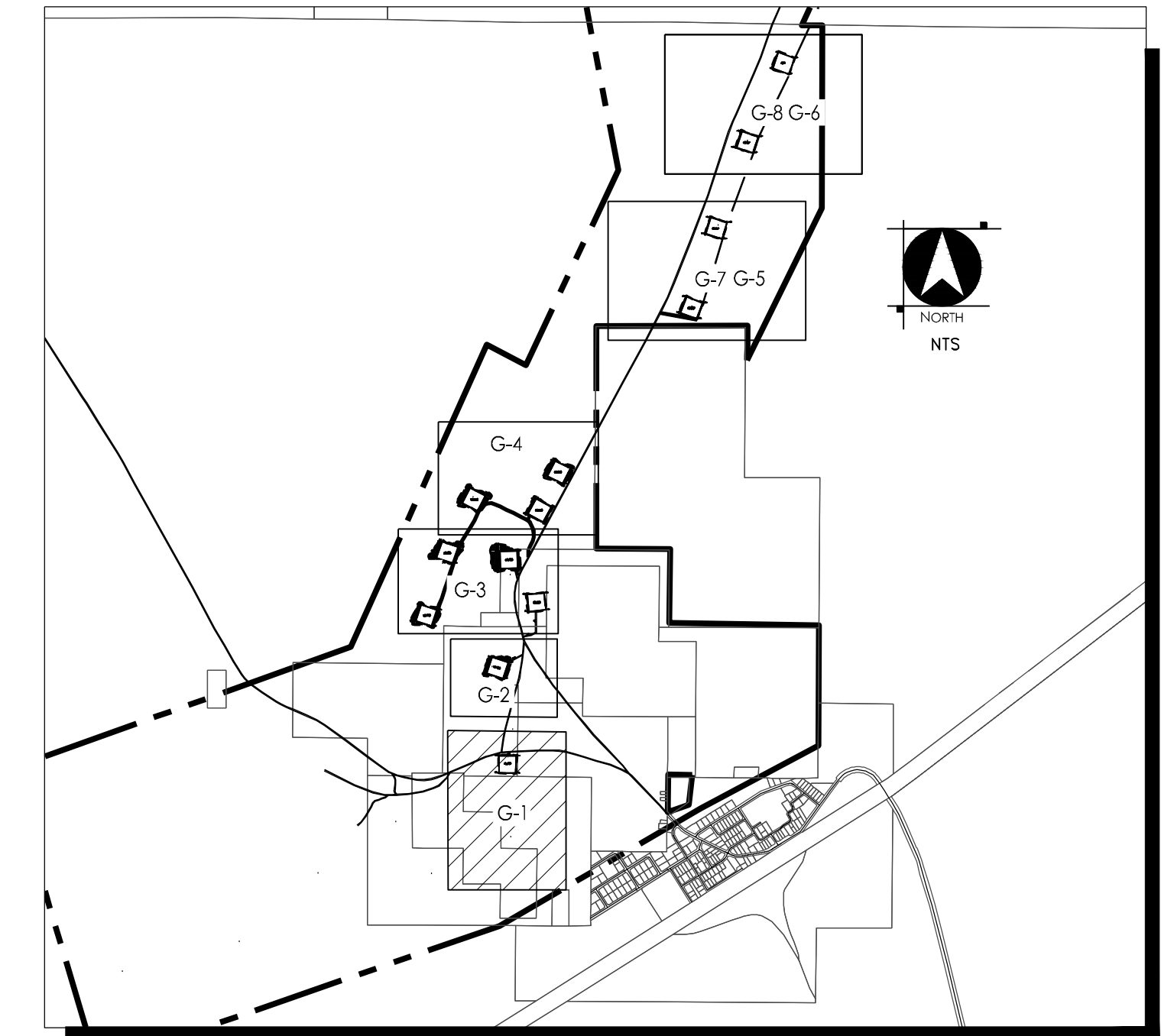
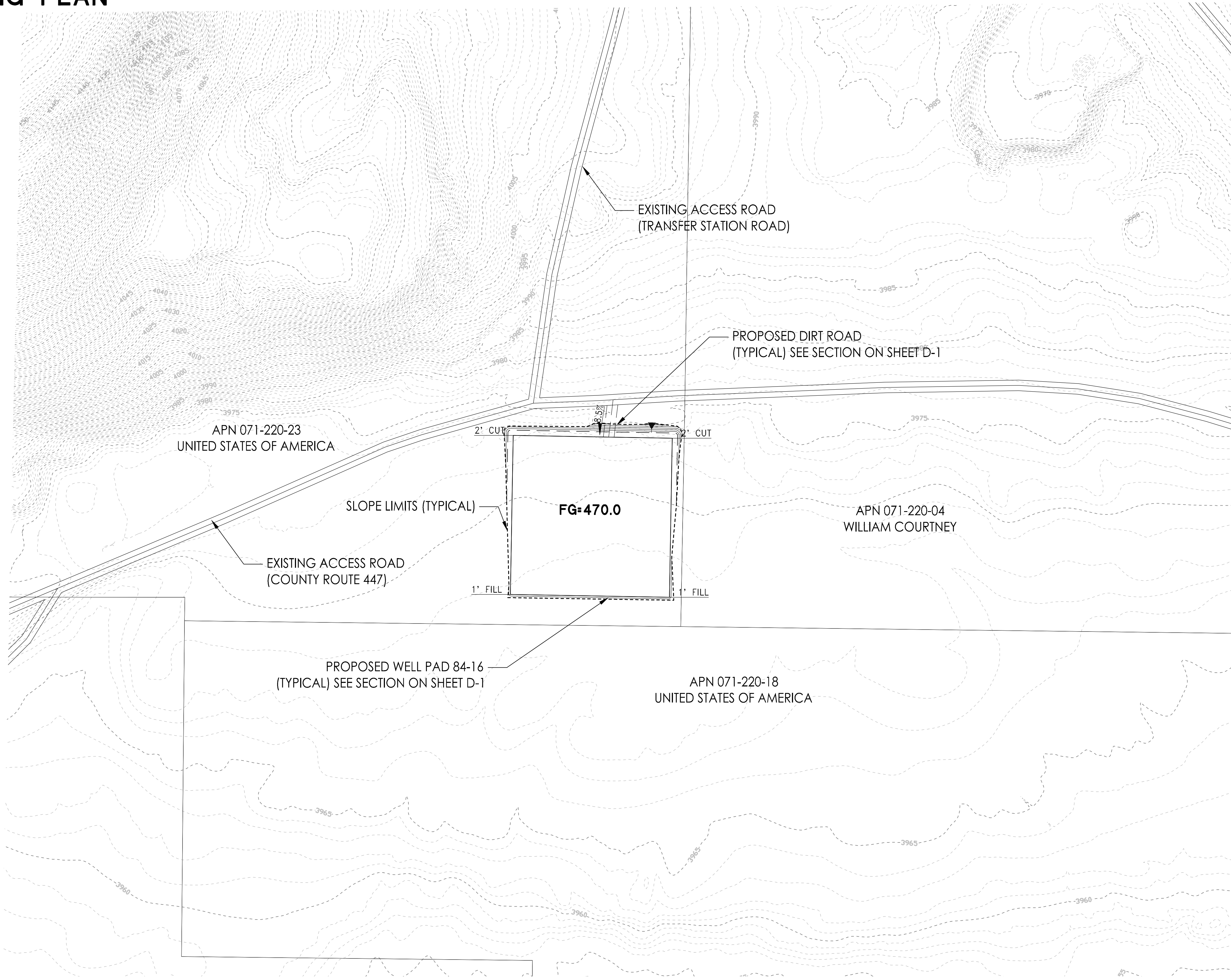

KEY MAP

TYPICAL GRADING NOTES:

- 1) ADD 3500' TO ALL SPOT ELEVATIONS
- 2) ALL SLOPES 3:1 MAX
- 3) EXISTING CONTOUR INTERVAL THIS SHEET: 1 FOOT
- 4) PROPOSED CONTOUR INTERVAL THIS SHEET: 1 FOOT

INDIVIDUAL PAD GRADING DISTURBANCE AND QUANTITIES:

PAD 84-16
 DISTURBANCE: 100,000 SQUARE FEET
 CUT: 1,630 CUBIC YARDS (CY)
 FILL: 1,520 CY
 EXPORT/IMPORT (NO SHRINK/SWELL): 110 CY EXPORT

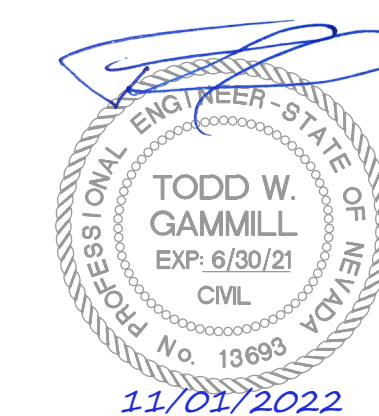

LEGEND

- PROJECT AREA
- - - EX. DIRT ROAD TO BE IMPROVED
- - - PROPOSED DIRT ROAD
- EXISTING ROAD TO REMAIN/BE UTILIZED
- EXISTING PARCEL LINE

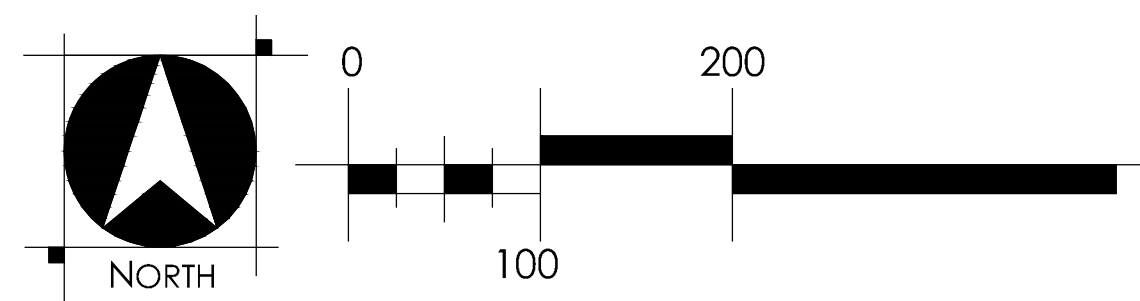

ORMAT GERLACH GEOTHERMAL WELL EXPLORATION GRADING PLAN

WOOD RODGERS
 BUILDING RELATIONSHIPS ONE PROJECT AT A TIME
 1361 Corporate Boulevard Tel 775.823.4068
 Reno, NV 89502 Fax 775.823.4066

\\woodrogers.com\ProductionData\Jobs-Renee\Yuba\707_Steamboat_Hills_Geothermal\019_Planning\Org\Administrative Permits\CO3_AP_GWE_G01.dwg 11/1/2022 1:12 PM Todd Gammill

ORMAT GERLACH GEOTHERMAL WELL EXPLORATION

ADMINISTRATIVE PERMIT GRADING PLAN

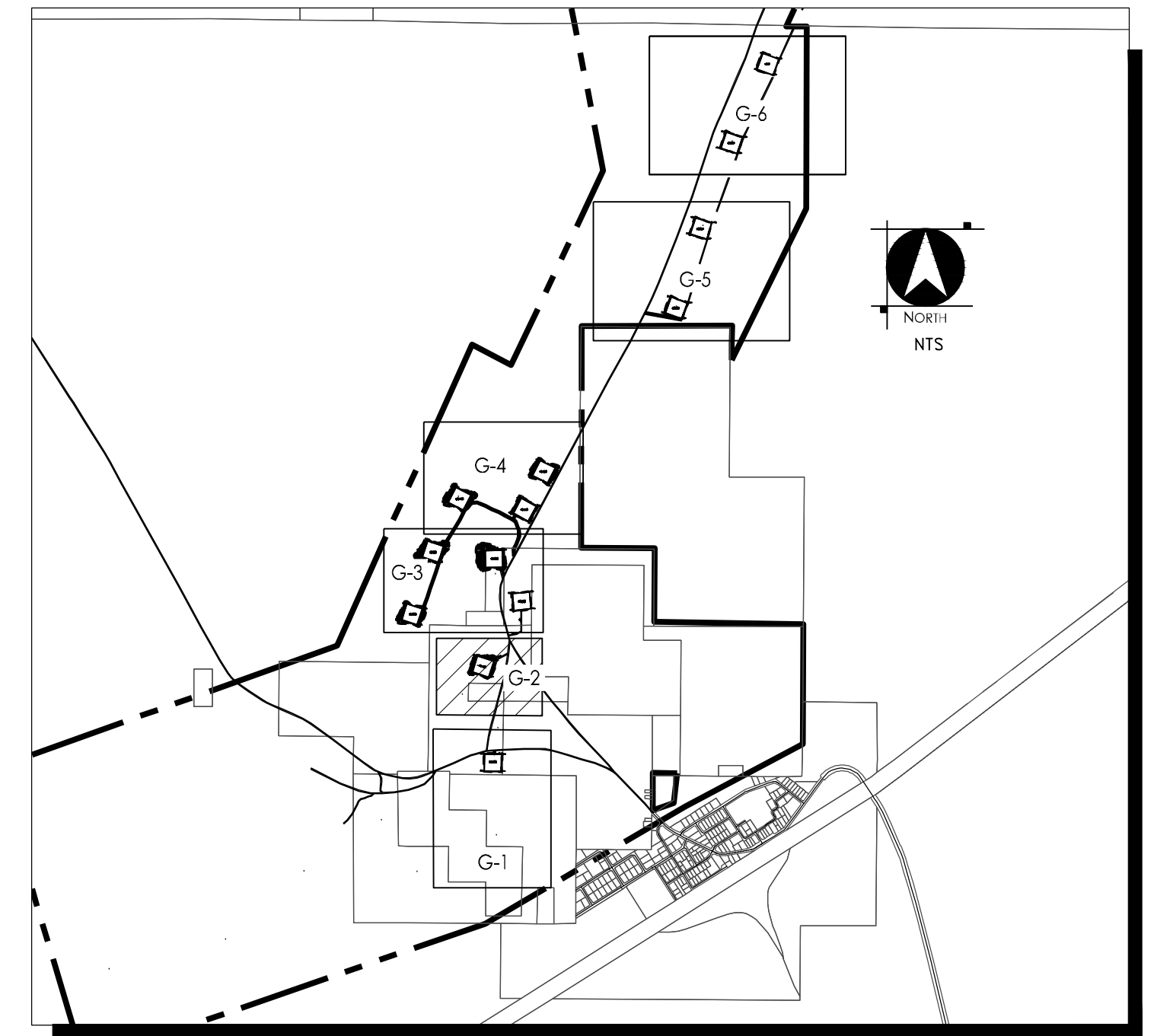

KEY MAP



- TYPICAL GRADING NOTES:
- 1) ADD 3500' TO ALL SPOT ELEVATIONS
 - 2) ALL SLOPES 3:1 MAX
 - 3) EXISTING CONTOUR INTERVAL THIS SHEET: 5 FOOT
 - 4) PROPOSED CONTOUR INTERVAL THIS SHEET: 5 FOOT

INDIVIDUAL PAD GRADING DISTURBANCE AND QUANTITIES:

PAD 82-16
 DISTURBANCE: 150,000 SQUARE FEET
 CUT: 17,000 CUBIC YARDS (CY)
 FILL: 20,700 CY
 EXPORT/IMPORT (NO SHRINK/SWELL): 3,700 CY IMPORT

LEGEND

- PROJECT AREA
- EX. DIRT ROAD TO BE IMPROVED
- PROPOSED DIRT ROAD
- EXISTING ROAD TO REMAIN/BE UTILIZED
- EXISTING PARCEL LINE

ORMAT GERLACH GEOTHERMAL WELL EXPLORATION GRADING PLAN

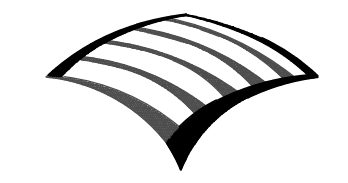

WOOD RODGERS
 BUILDING RELATIONSHIPS ONE PROJECT AT A TIME
 1361 Corporate Boulevard Tel 775.823.4068
 Reno, NV 89502 Fax 775.823.4066

1707.019 NOVEMBER 2022
 SHEET **G-2 OF 9**

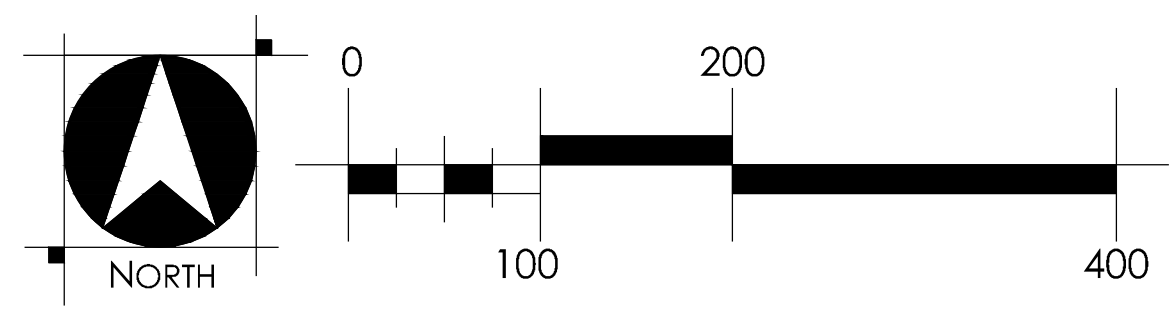
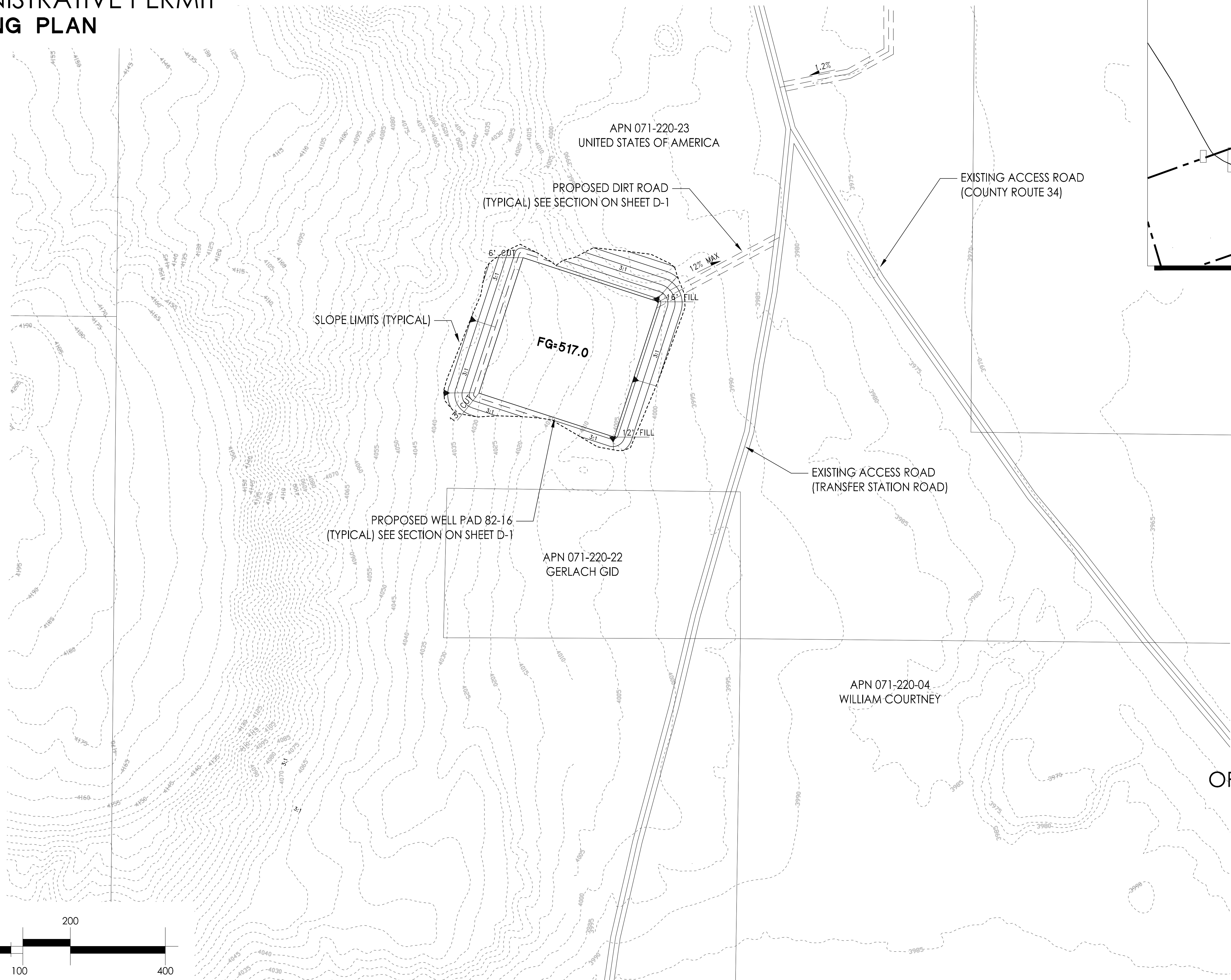

J:\Vabs\1707_Steamboat_Hills_Geothermal\019_Gerlach_Well_Explor_OA\Planning\Org\Administrative Permits\004_AF_GME_002.dwg 11/17/2022 11:07 AM Todd Gammill

ORMAT GERLACH GEOTHERMAL WELL EXPLORATION

ADMINISTRATIVE PERMIT GRADING PLAN

INDIVIDUAL PAD GRADING DISTURBANCE AND QUANTITIES:

PAD 188-10
 DISTURBANCE: 94,900 SQUARE FEET
 CUT: 2,400 CUBIC YARDS (CY)
 FILL: 1,800 CY
 EXPORT/IMPORT (NO SHRINK/SWELL): 600 CY EXPORT

INDIVIDUAL PAD GRADING DISTURBANCE AND QUANTITIES:

PAD 87-9
 DISTURBANCE: 205,200 SQUARE FEET
 CUT: 101,500 CUBIC YARDS (CY)
 FILL: 15,300 CY
 EXPORT/IMPORT (NO SHRINK/SWELL): 86,200 CY EXPORT

INDIVIDUAL PAD GRADING DISTURBANCE AND QUANTITIES:

PAD 77-9
 DISTURBANCE: 205,200 SQUARE FEET
 CUT: 101,500 CUBIC YARDS (CY)
 FILL: 15,300 CY
 EXPORT/IMPORT (NO SHRINK/SWELL): 86,200 CY EXPORT

INDIVIDUAL PAD GRADING DISTURBANCE AND QUANTITIES:

PAD 68-9
 DISTURBANCE: 160,500 SQUARE FEET
 CUT: 20,000 CUBIC YARDS (CY)
 FILL: 20,600 CY
 EXPORT/IMPORT (NO SHRINK/SWELL): 600 CY EXPORT

INDIVIDUAL PAD GRADING DISTURBANCE AND QUANTITIES:

PAD 77-9
 DISTURBANCE: 205,200 SQUARE FEET
 CUT: 101,500 CUBIC YARDS (CY)
 FILL: 15,300 CY
 EXPORT/IMPORT (NO SHRINK/SWELL): 86,200 CY EXPORT

INDIVIDUAL PAD GRADING DISTURBANCE AND QUANTITIES:

PAD 68-9
 DISTURBANCE: 160,500 SQUARE FEET
 CUT: 20,000 CUBIC YARDS (CY)
 FILL: 20,600 CY
 EXPORT/IMPORT (NO SHRINK/SWELL): 600 CY EXPORT

INDIVIDUAL PAD GRADING DISTURBANCE AND QUANTITIES:

PAD 68-9
 DISTURBANCE: 160,500 SQUARE FEET
 CUT: 20,000 CUBIC YARDS (CY)
 FILL: 20,600 CY
 EXPORT/IMPORT (NO SHRINK/SWELL): 600 CY EXPORT

INDIVIDUAL PAD GRADING DISTURBANCE AND QUANTITIES:

PAD 68-9
 DISTURBANCE: 160,500 SQUARE FEET
 CUT: 20,000 CUBIC YARDS (CY)
 FILL: 20,600 CY
 EXPORT/IMPORT (NO SHRINK/SWELL): 600 CY EXPORT

INDIVIDUAL PAD GRADING DISTURBANCE AND QUANTITIES:

PAD 68-9
 DISTURBANCE: 160,500 SQUARE FEET
 CUT: 20,000 CUBIC YARDS (CY)
 FILL: 20,600 CY
 EXPORT/IMPORT (NO SHRINK/SWELL): 600 CY EXPORT

INDIVIDUAL PAD GRADING DISTURBANCE AND QUANTITIES:

PAD 68-9
 DISTURBANCE: 160,500 SQUARE FEET
 CUT: 20,000 CUBIC YARDS (CY)
 FILL: 20,600 CY
 EXPORT/IMPORT (NO SHRINK/SWELL): 600 CY EXPORT

INDIVIDUAL PAD GRADING DISTURBANCE AND QUANTITIES:

PAD 68-9
 DISTURBANCE: 160,500 SQUARE FEET
 CUT: 20,000 CUBIC YARDS (CY)
 FILL: 20,600 CY
 EXPORT/IMPORT (NO SHRINK/SWELL): 600 CY EXPORT

INDIVIDUAL PAD GRADING DISTURBANCE AND QUANTITIES:

PAD 68-9
 DISTURBANCE: 160,500 SQUARE FEET
 CUT: 20,000 CUBIC YARDS (CY)
 FILL: 20,600 CY
 EXPORT/IMPORT (NO SHRINK/SWELL): 600 CY EXPORT

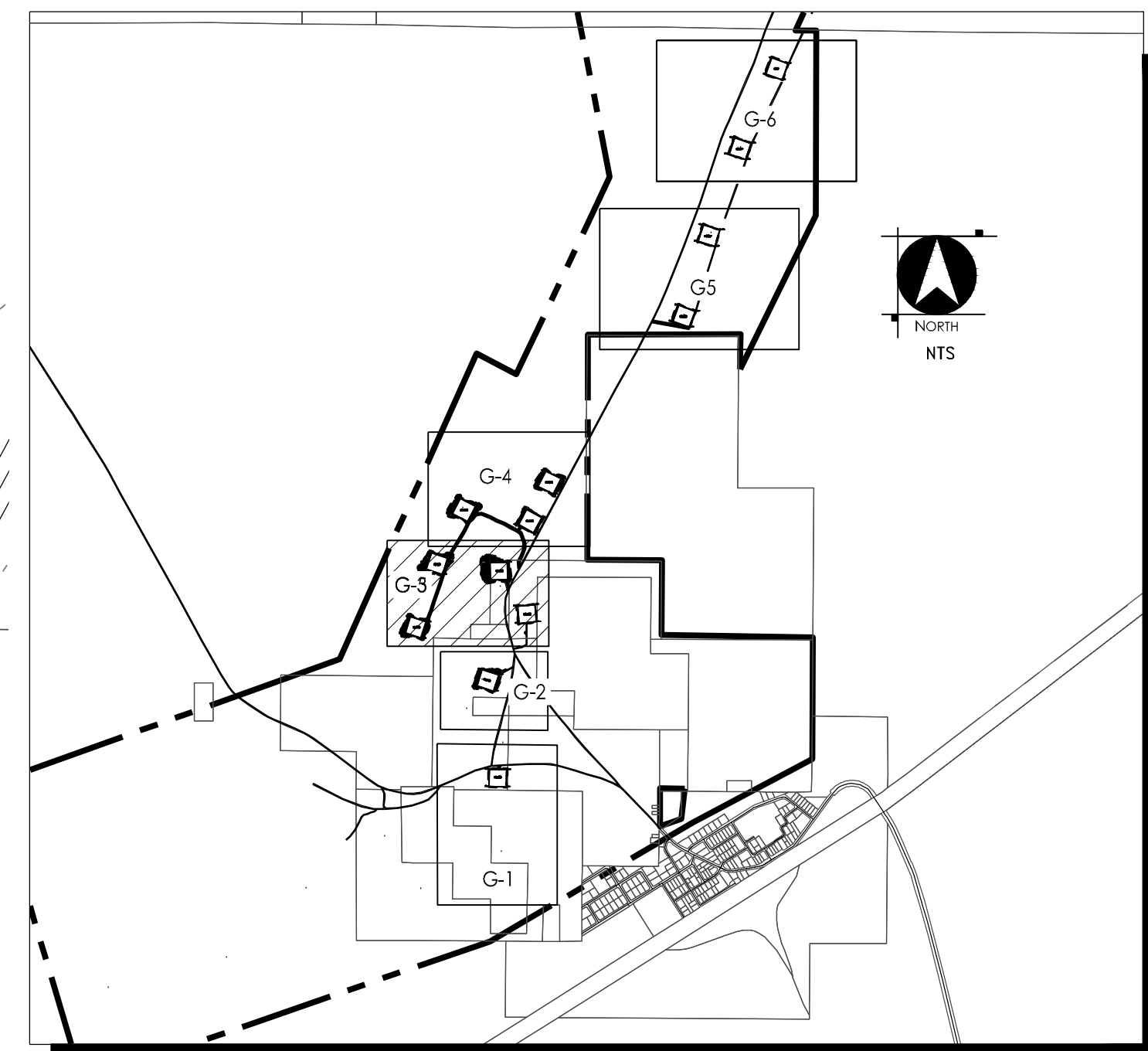
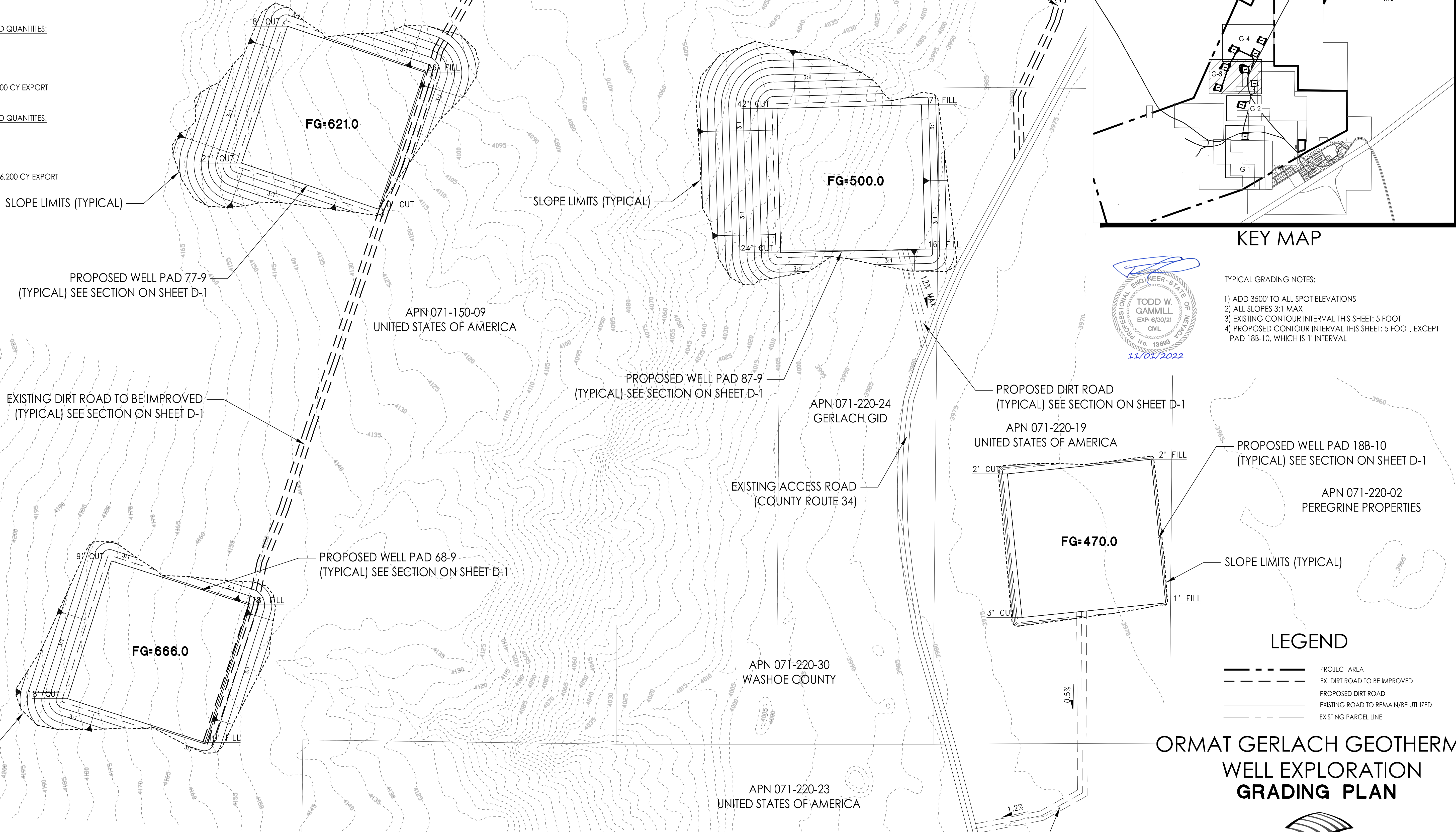

KEY MAP

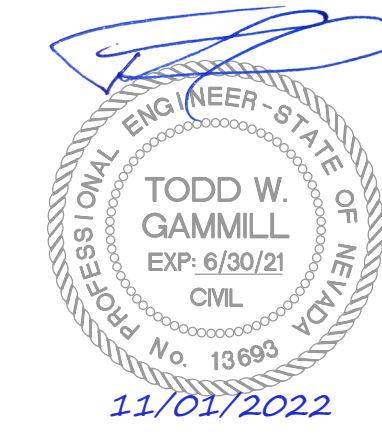

- TYPICAL GRADING NOTES:**
- 1) ADD 3500' TO ALL SPOT ELEVATIONS
 - 2) ALL SLOPES 3:1 MAX
 - 3) EXISTING CONTOUR INTERVAL THIS SHEET: 5 FOOT
 - 4) PROPOSED CONTOUR INTERVAL THIS SHEET: 5 FOOT, EXCEPT PAD 188-10, WHICH IS 1' INTERVAL

LEGEND

- PROJECT AREA
- - - EX. DIRT ROAD TO BE IMPROVED
- - - PROPOSED DIRT ROAD
- - - EXISTING ROAD TO REMAIN/BE UTILIZED
- - - EXISTING PARCEL LINE

ORMAT GERLACH GEOTHERMAL WELL EXPLORATION GRADING PLAN

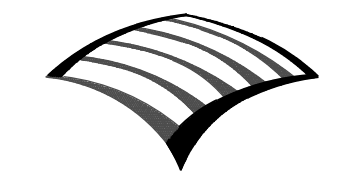

WOOD RODGERS
 BUILDING RELATIONSHIPS ONE PROJECT AT A TIME
 1361 Corporate Boulevard Tel 775.823.4068
 Reno, NV 89502 Fax 775.823.4066

1707.019 NOVEMBER 2022

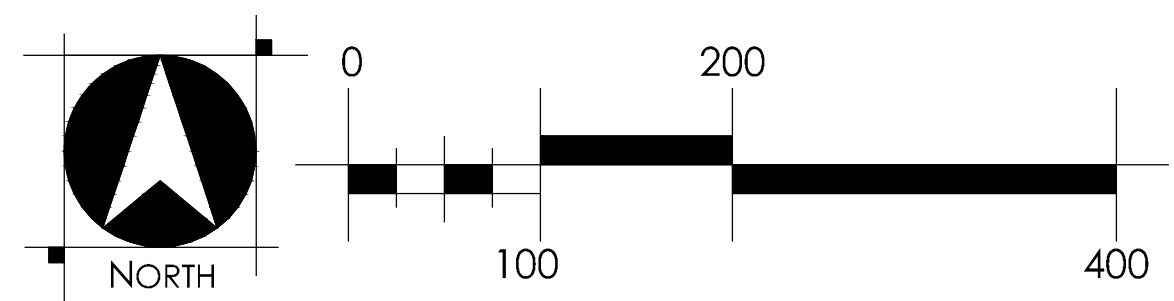

J:\Vabs\1707_Stemboat_Hills_Geothermal\019_Gerlach_Well_Explor_OA\Planning\Uwg\Administrative_Permit\005_AF_GME.dwg 11/17/2022 11:07 AM Todd Gammill

ORMAT GERLACH GEOTHERMAL WELL EXPLORATION

ADMINISTRATIVE PERMIT GRADING PLAN

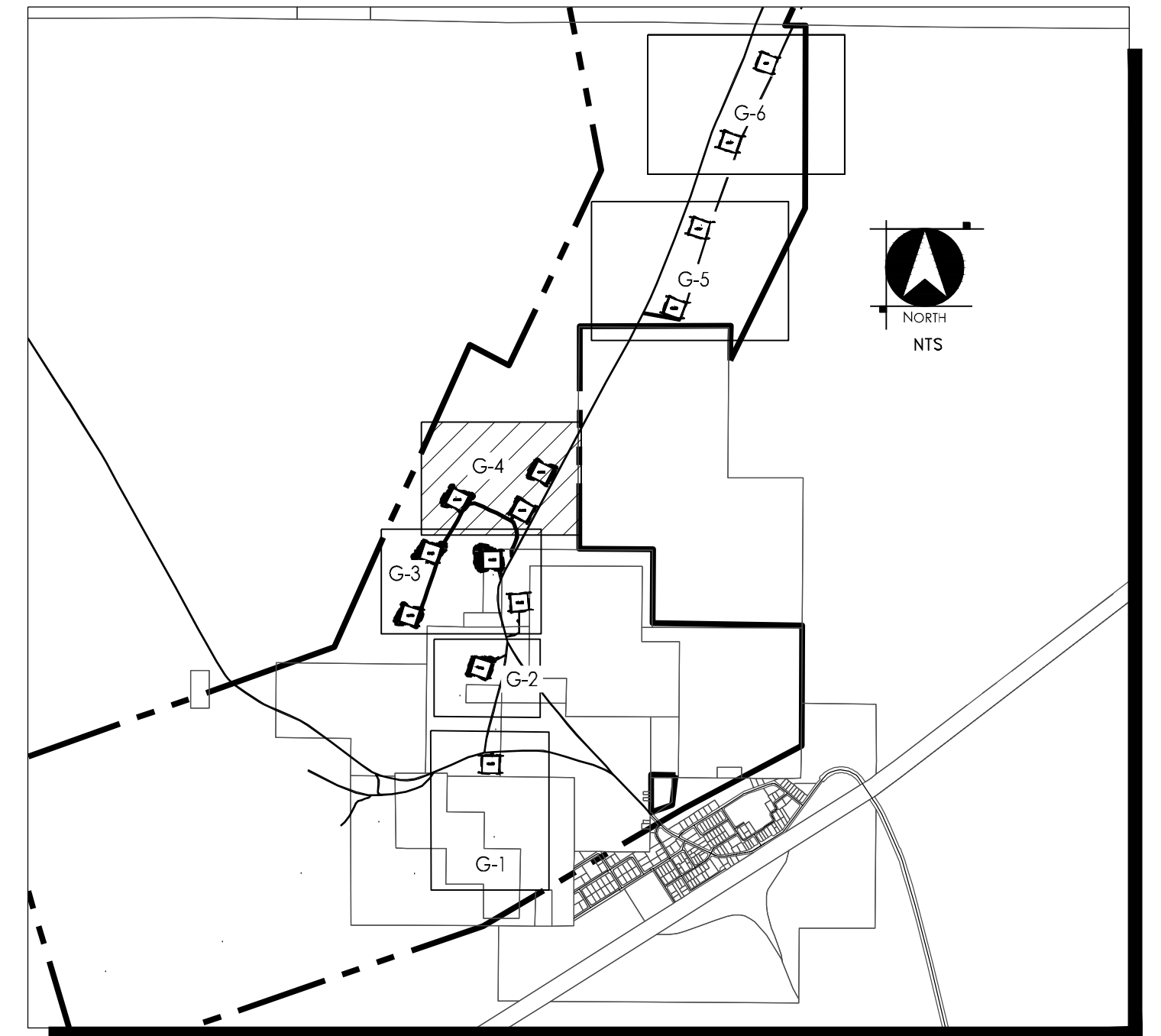
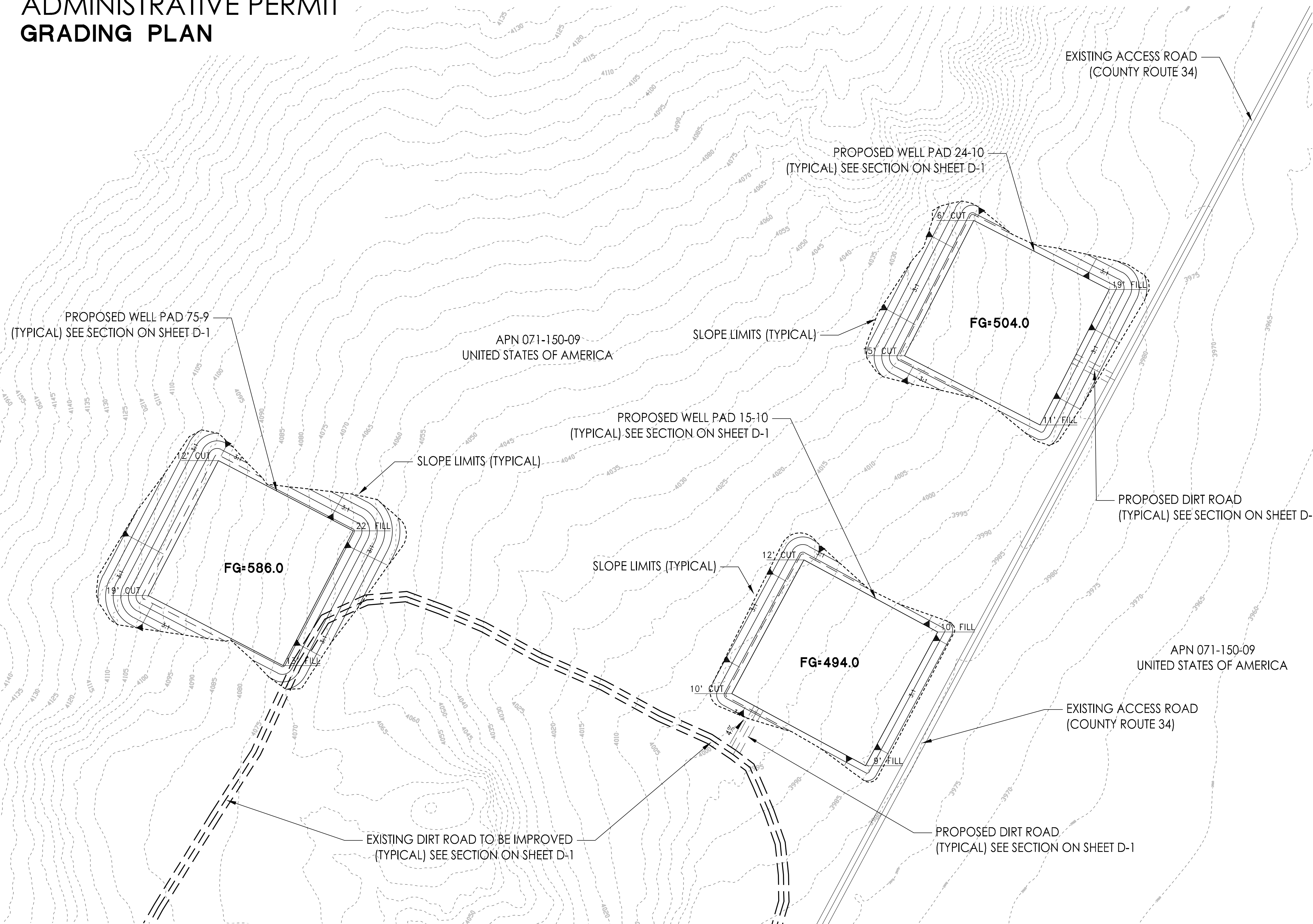

KEY MAP

- TYPICAL GRADING NOTES:**
- 1) ADD 3500' TO ALL SPOT ELEVATIONS
 - 2) ALL SLOPES 3:1 MAX
 - 3) EXISTING CONTOUR INTERVAL THIS SHEET: 5 FOOT
 - 4) PROPOSED CONTOUR INTERVAL THIS SHEET: 5 FOOT

INDIVIDUAL PAD GRADING DISTURBANCE AND QUANTITIES:

Well Pad	Disturbance (SQ FT)	Cut (CY)	Fill (CY)	Export/Import (CY)
PAD 15-10	121,300	12,500	12,700	200 CY IMPORT
PAD 75-9	170,500	25,300	28,800	3,500 CY IMPORT
PAD 24-10	147,800	19,100	21,400	2,300 CY IMPORT

APN 071-150-01
BURNING MAN PROJECT

LEGEND

--- (Dashed line)	PROJECT AREA
- - - (Long dashed line)	EX. DIRT ROAD TO BE IMPROVED
--- (Short dashed line)	PROPOSED DIRT ROAD
— (Solid line)	EXISTING ROAD TO REMAIN/BE UTILIZED
- - - (Dash-dot line)	EXISTING PARCEL LINE

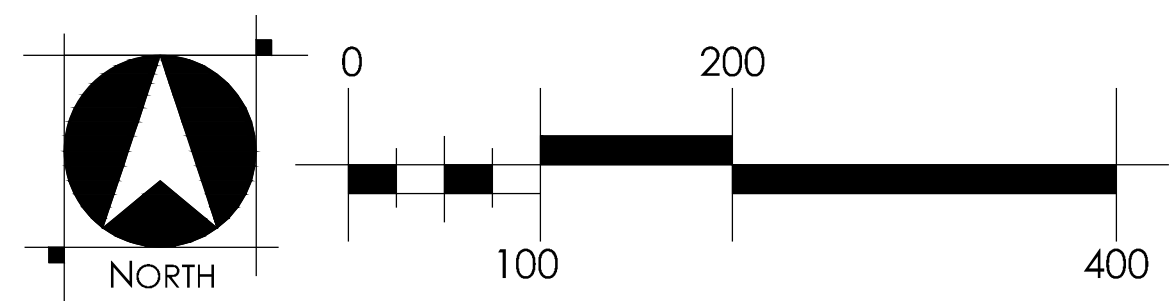

ORMAT GERLACH GEOTHERMAL WELL EXPLORATION GRADING PLAN

WOOD RODGERS
 BUILDING RELATIONSHIPS ONE PROJECT AT A TIME
 1361 Corporate Boulevard Tel 775.823.4068
 Reno, NV 89502 Fax 775.823.4066

J:\Vabs\1707_Stemboat_Hills_Geothermal\019_Gerlach_Well_Explor_OA\Planning\Owg\Administrative Permits\006_AF_GME_004.dwg 11/17/2022 11:08 AM Todd Gammill

ORMAT GERLACH GEOTHERMAL WELL EXPLORATION

ADMINISTRATIVE PERMIT GRADING PLAN

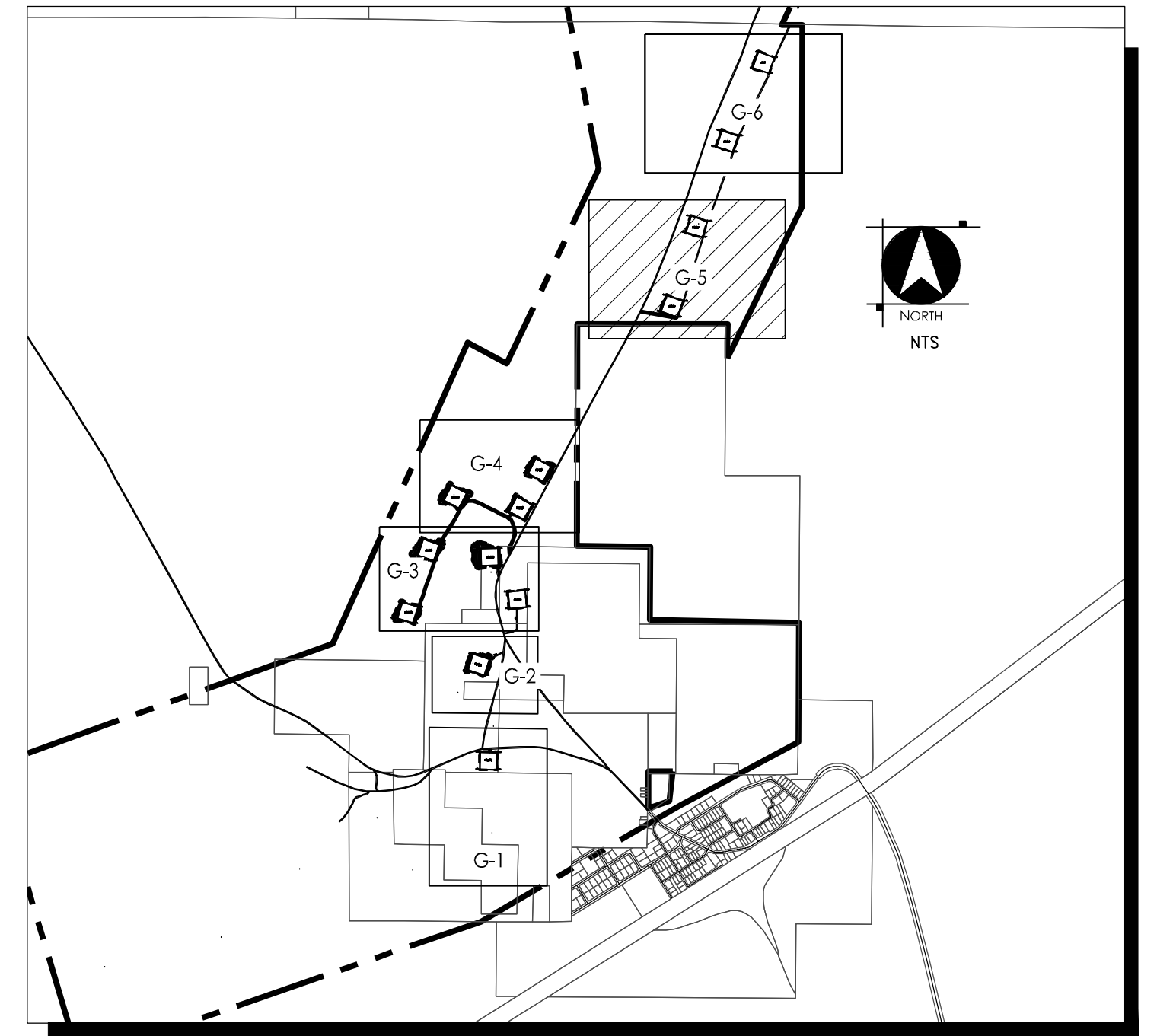

KEY MAP

TYPICAL GRADING NOTES:

- 1) ADD 3500' TO ALL SPOT ELEVATIONS
- 2) ALL SLOPES 3:1 MAX
- 3) EXISTING CONTOUR INTERVAL THIS SHEET: 1 FOOT
- 4) PROPOSED CONTOUR INTERVAL THIS SHEET: 1 FOOT

INDIVIDUAL PAD GRADING DISTURBANCE AND QUANTITIES:

PAD 58-3
 DISTURBANCE: 100,800 SQUARE FEET
 CUT: 5,000 CUBIC YARDS (CY)
 FILL: 3,300 CY
 EXPORT/IMPORT (NO SHRINK/SWELL): 1,700 CY EXPORT

INDIVIDUAL PAD GRADING DISTURBANCE AND QUANTITIES:

PAD 66-3
 DISTURBANCE: 92,400 SQUARE FEET
 CUT: 1,750 CUBIC YARDS (CY)
 FILL: 700 CY
 EXPORT/IMPORT (NO SHRINK/SWELL): 1,050 CY EXPORT

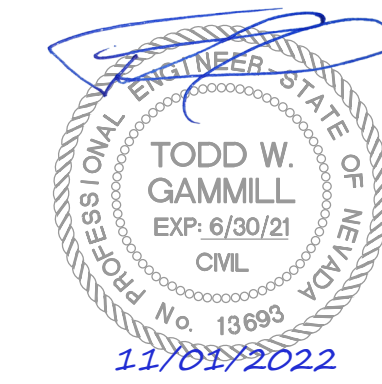

LEGEND

- PROJECT AREA
- EX. DIRT ROAD TO BE IMPROVED
- PROPOSED DIRT ROAD
- EXISTING ROAD TO REMAIN/BE UTILIZED
- EXISTING PARCEL LINE

ORMAT GERLACH GEOTHERMAL WELL EXPLORATION GRADING PLAN

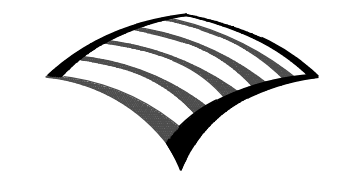

WOOD RODGERS
 BUILDING RELATIONSHIPS ONE PROJECT AT A TIME

1361 Corporate Boulevard Tel 775.823.4068
 Reno, NV 89502 Fax 775.823.4066

1707.019 NOVEMBER 2022

SHEET **G-5** OF 9

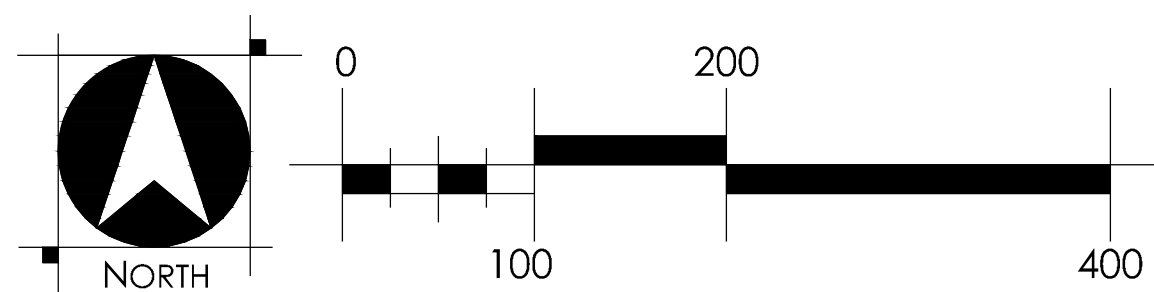

J:\Vabs\1707_Steamboat_Hills_Geothermal\019_Gerlach_Well_Explor_OA\Planning\Uwg\Administrative Permits\007_AF_GME.dwg 11/17/2022 11:08 AM Todd Gammill

ORMAT GERLACH GEOTHERMAL WELL EXPLORATION

ADMINISTRATIVE PERMIT GRADING PLAN

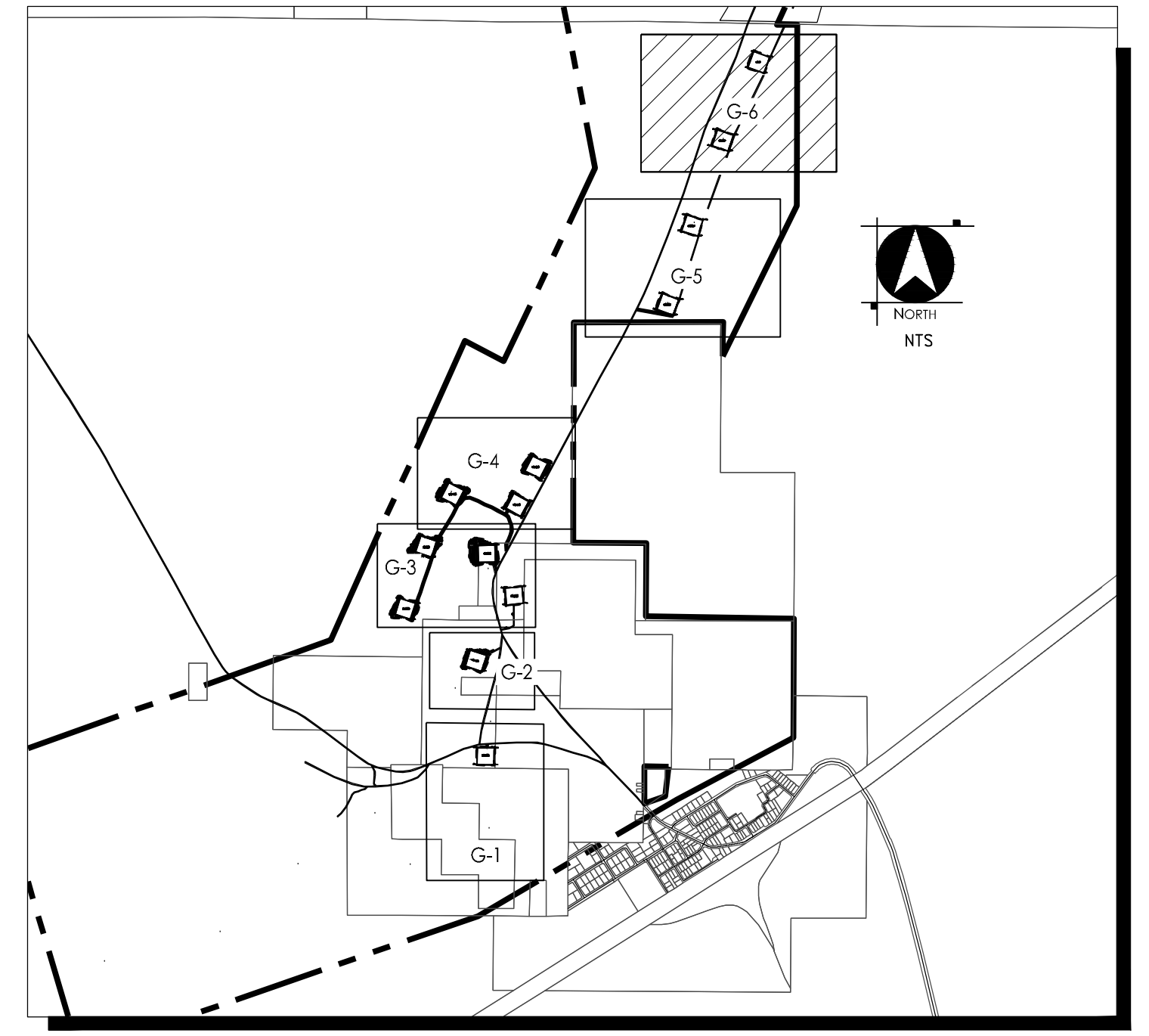
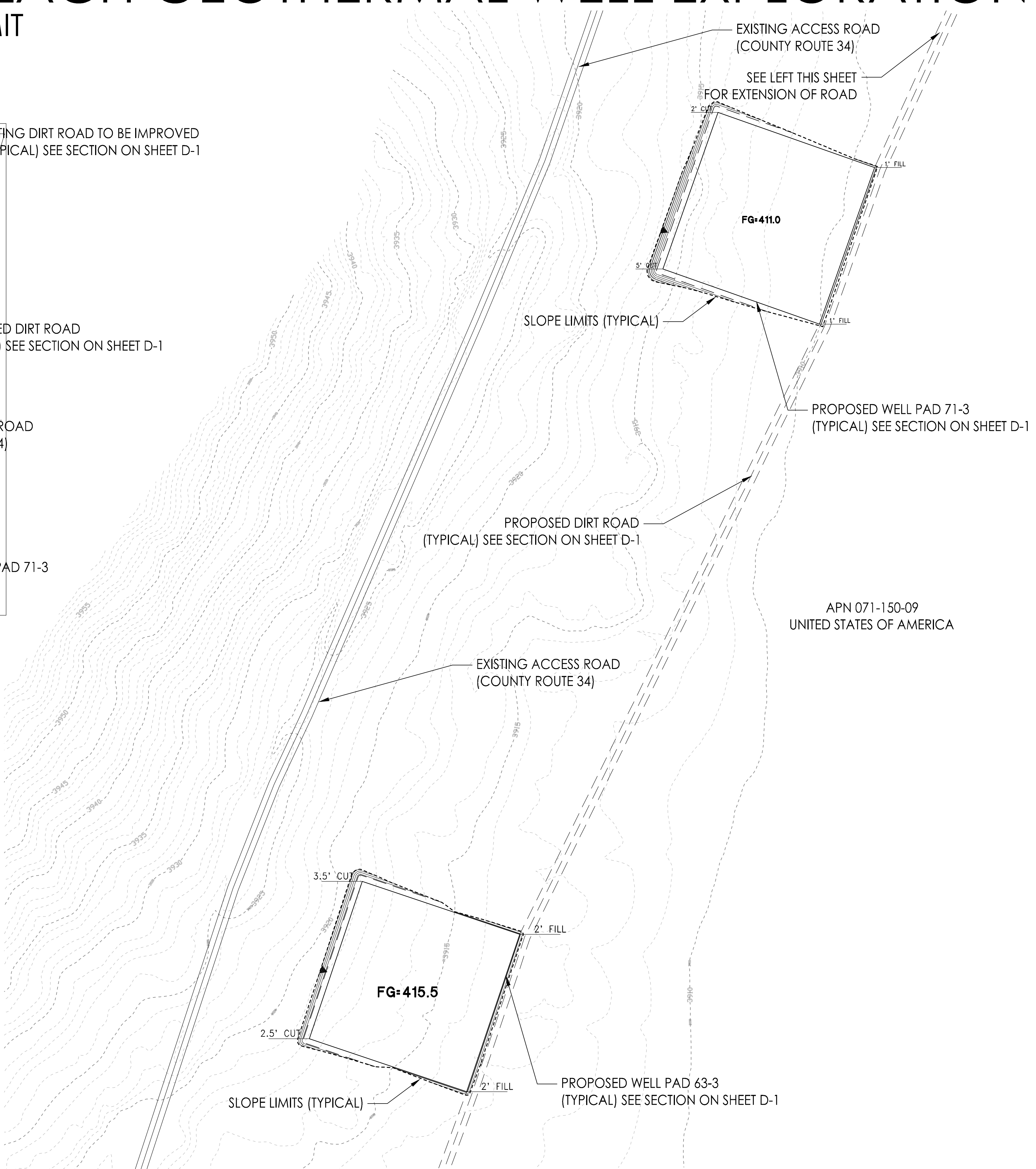
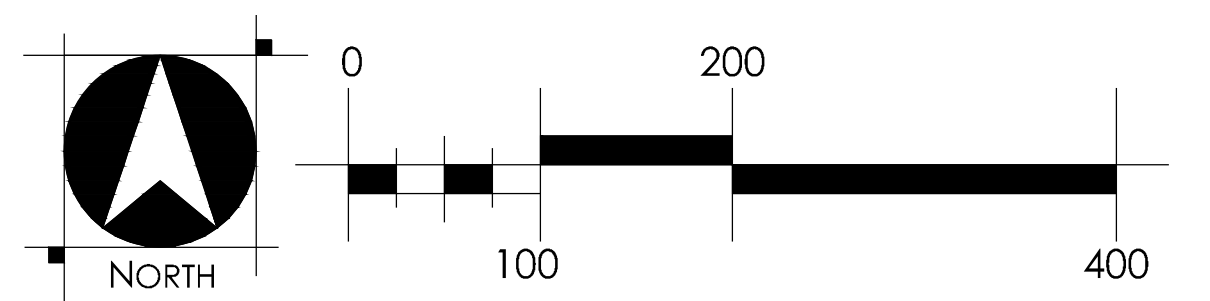
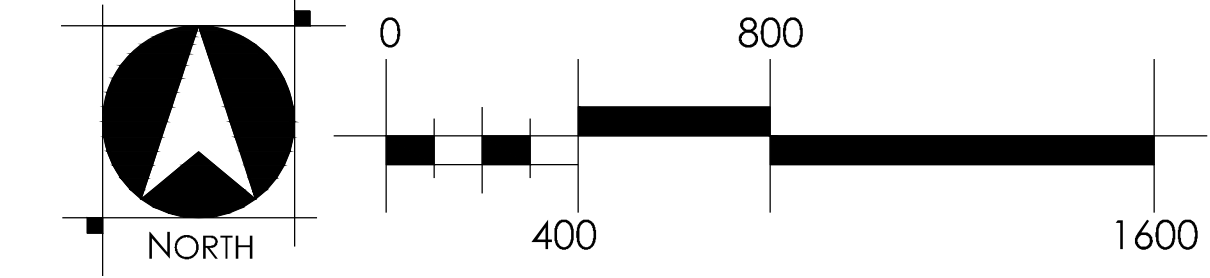
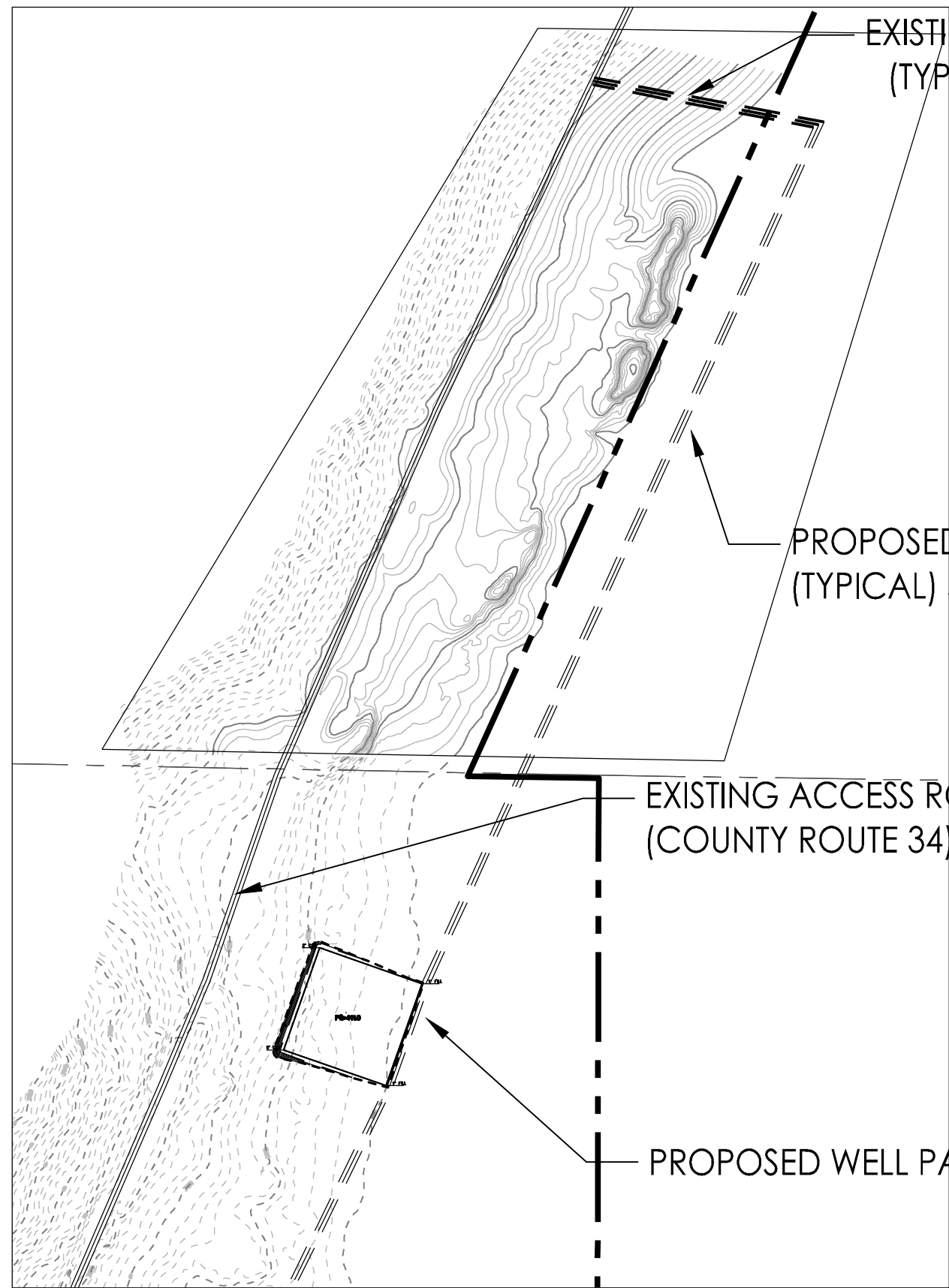

KEY MAP

- TYPICAL GRADING NOTES:**
- 1) ADD 3500' TO ALL SPOT ELEVATIONS
 - 2) ALL SLOPES 3:1 MAX
 - 3) EXISTING CONTOUR INTERVAL THIS SHEET: 1 FOOT
 - 4) PROPOSED CONTOUR INTERVAL THIS SHEET: 1 FOOT

INDIVIDUAL PAD GRADING DISTURBANCE AND QUANTITIES:

PAD 63-3
 DISTURBANCE: 95,800 SQUARE FEET
 CUT: 2,900 CUBIC YARDS (CY)
 FILL: 1,800 CY
 EXPORT/IMPORT (NO SHRINK/SWELL): 1,100 CY EXPORT

INDIVIDUAL PAD GRADING DISTURBANCE AND QUANTITIES:

PAD 71-3
 DISTURBANCE: 91,500 SQUARE FEET
 CUT: 2,130 CUBIC YARDS (CY)
 FILL: 2,250 CY
 EXPORT/IMPORT (NO SHRINK/SWELL): 120 CY IMPORT



LEGEND

- PROJECT AREA
- - - EX. DIRT ROAD TO BE IMPROVED
- PROPOSED DIRT ROAD
- EXISTING ROAD TO REMAIN/BE UTILIZED
- EXISTING PARCEL LINE

ORMAT GERLACH GEOTHERMAL WELL EXPLORATION GRADING PLAN

WOOD RODGERS
 BUILDING RELATIONSHIPS ONE PROJECT AT A TIME
 1361 Corporate Boulevard Tel 775.823.4068
 Reno, NV 89502 Fax 775.823.4066

J:\Vabs\1707_Steamboat_Hills_Geothermal\019_Gerlach_Well_Explor_OA\Planning\Owg\Administrative Permits\008_Ap_GME.dwg 11/7/2022 11:08 AM Todd Gammill

ORMAT GERLACH GEOTHERMAL WELL EXPLORATION

ADMINISTRATIVE PERMIT DETAIL SHEET

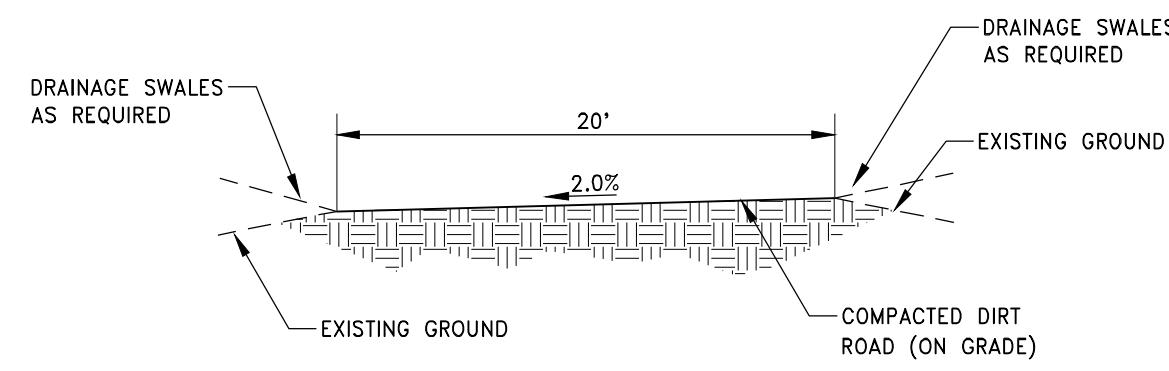
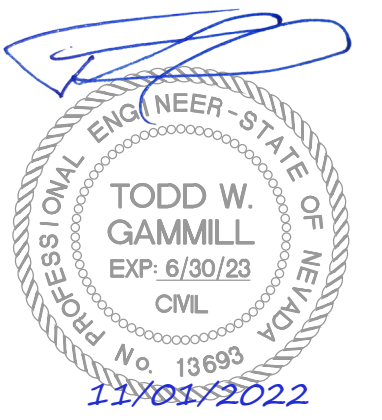

TYPICAL NEW ROAD SECTION
NOT TO SCALE

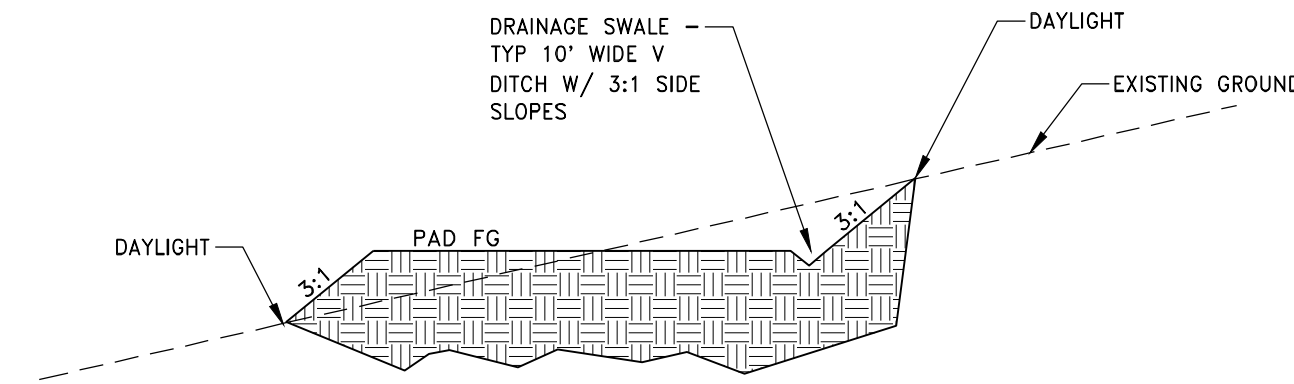

TYPICAL PAD GRADING SECTION
NOT TO SCALE

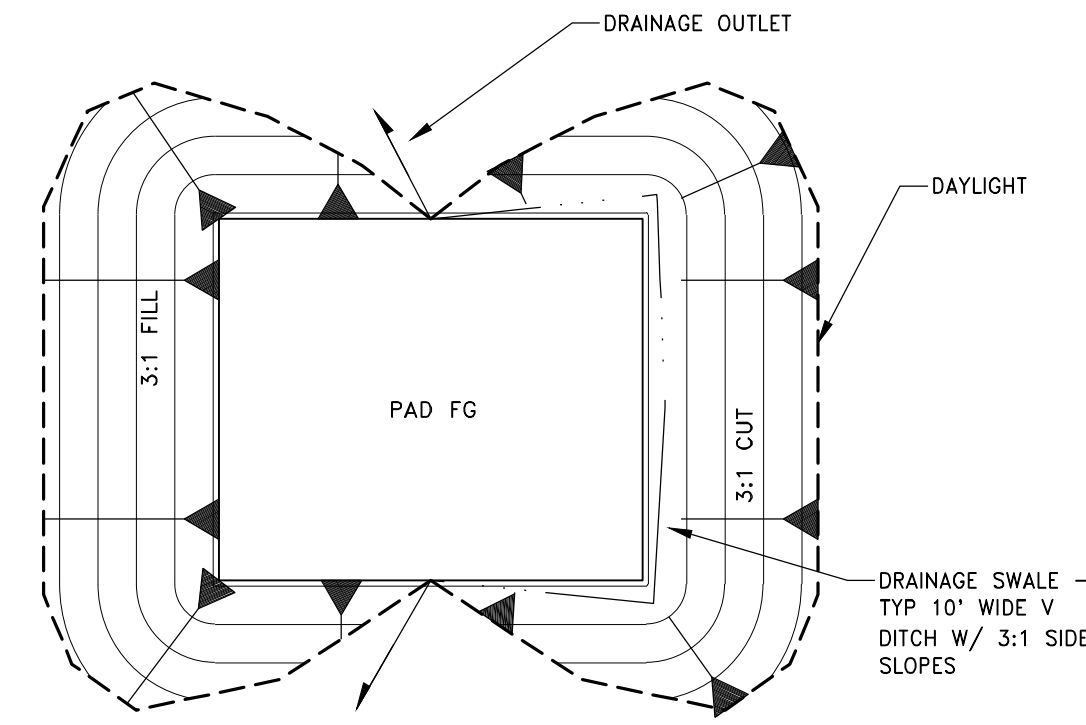

TYPICAL PAD GRADING PLAN
NOT TO SCALE

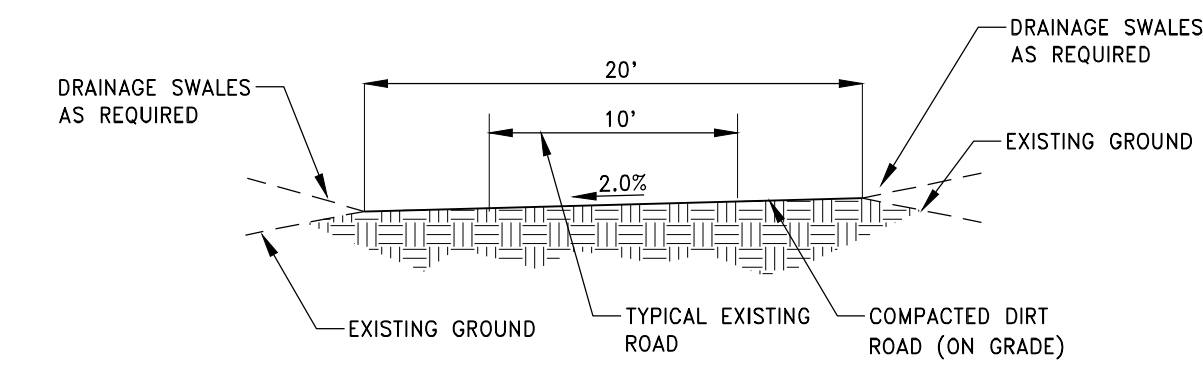

TYPICAL IMPROVED EXISTING ROAD SECTION
NOT TO SCALE

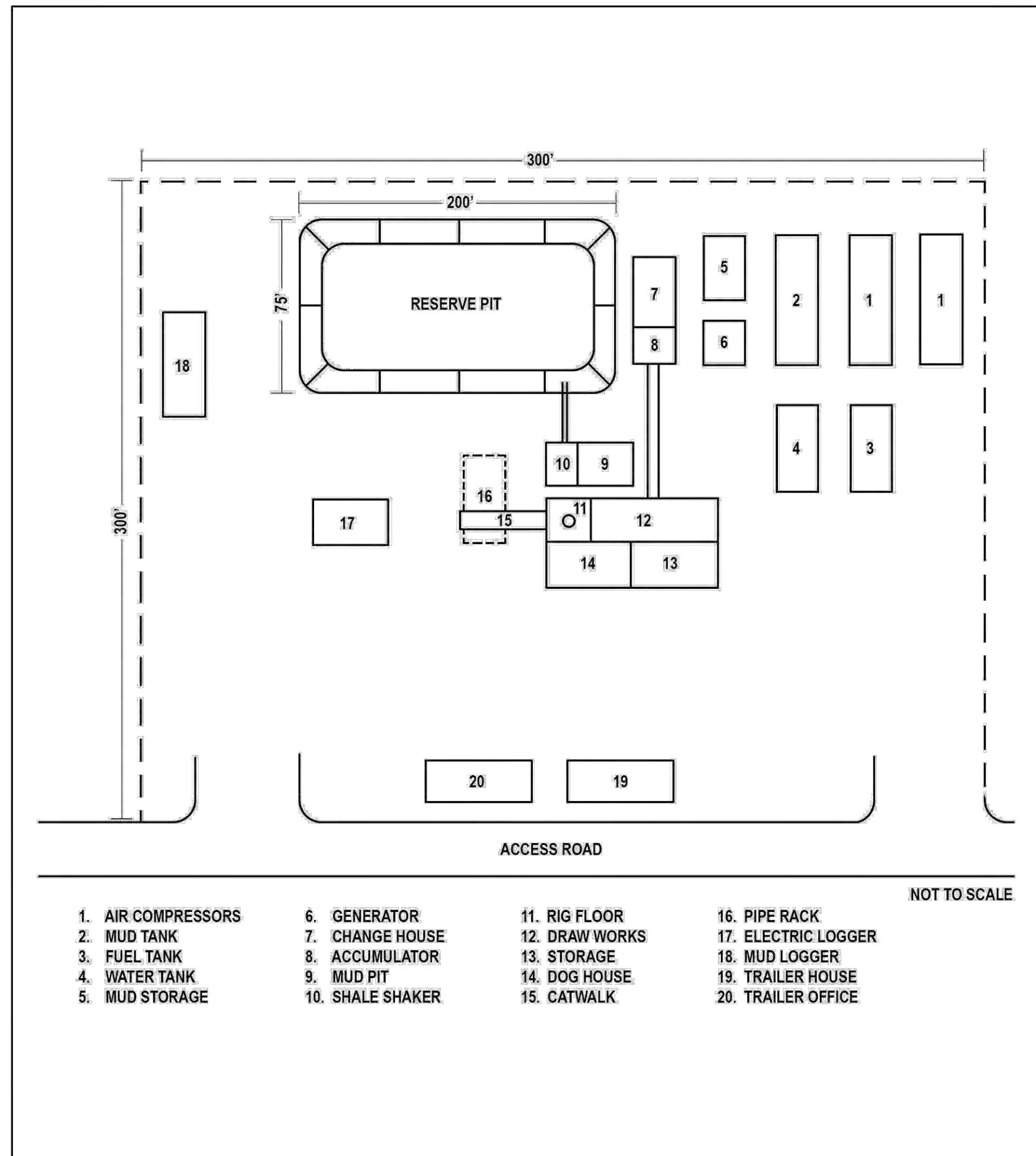

Gerlach Geothermal Exploration Project
Washoe County, Nevada, USA

Figure 5: Well Pad Layout and Design

ORMAT GERLACH GEOTHERMAL WELL EXPLORATION DETAIL SHEET

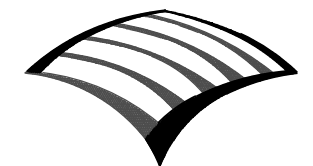

WOOD RODGERS
BUILDING RELATIONSHIPS ONE PROJECT AT A TIME

1361 Corporate Boulevard Tel 775.823.4068
Reno, NV 89502 Fax 775.823.4066

1707.019

NOVEMBER 2022

SHEET D-1 OF 9

TYPICAL GEOTECHNICAL WELL PAD LAYOUT
NOT TO SCALE

J:\Vabs\1707_Steamboat_Hills_Geothermal\019_Gerlach_Well_Explor_OA\Planning\Org\Administrative Permits\009_AF_GME_D01.dwg 11/1/2022 11:09 AM Todd Gammill

Section 4

OPERATIONS PLAN
(43 CFR SUBPART 3250)

GERLACH
GEOHERMAL EXPLORATION PROJECT

FEDERAL GEOTHERMAL LEASES:

NVN55718
NVN75228
NVN98640
NVN98641
NVN100029

FEDERAL GEOTHERMAL LEASE UNIT:

NVN88151X

WASHOE COUNTY, NEVADA

SEPTEMBER 2022

APPLICANT:
ORNI 26 LLC
6140 PLUMAS ST
RENO, NV 89519

**GERLACH GEOTHERMAL EXPLORATION PROJECT
 ORNI 26 LLC
 OPERATIONS PLAN
 TABLE OF CONTENTS**

	<u>Page</u>
1.0 INTRODUCTION AND ORGANIZATION.....	1
1.1 Project Summary.....	1
1.2 Summary of Surface Disturbance	1
1.3 Operations Plan Organization	1
2.0 PROJECT DESCRIPTION	3
2.1 Geothermal Well Field.....	3
2.1.1 Well Field Location	3
2.1.2 Construction Procedures and Surface Disturbance.....	4
2.1.3 Well Drilling and Testing	5
2.2 Site Access and Road Construction	6
2.3 Water Requirements and Source.....	7
2.4 Aggregate Requirements and Source.....	8
2.5 Personnel.....	9
2.6 Surface Reclamation	9
3.0 ENVIRONMENTAL PROTECTION	10
3.1 Adopted Environmental Protection Measures	10
3.2 Fire Prevention and Control.....	10
3.3 Surface and Ground Water Protection	11
3.4 Wildlife Protection.....	12
3.5 Cultural Resource Protection	12
3.6 Minimization of Air Pollution	12
3.7 Minimization of Noise Pollution	13
3.8 Minimization of Hazards to Public Health and Safety	13
4.0 REFERENCES.....	17

TABLES

Table 1:	Federal Geothermal Leases.....	1
Table 2:	Maximum Project Surface Disturbance	1
Table 3:	Gerlach Well Sites on Federal Geothermal Leases.....	3
Table 4:	Well Drilling Specifics	5
Table 5:	Road Construction Lengths and Disturbance Totals	7
Table 6:	Existing Aggregate Sources.....	8

FIGURES

Figure 1:	Project Vicinity Map.....	18
Figure 2:	Federal Geothermal Lease Map.....	19
Figure 3:	Proposed Action Map (topo).....	20
Figure 4:	Proposed Action Map (aerial).....	21
Figure 5:	Well Pad Layout and Design.....	22
Figure 6:	Recommended Construction Standards for Exclosure Fences in Livestock Areas.....	23

APPENDICES

Appendix A Federal Geothermal Lease Stipulations

ACRONYMS AND ABBREVIATIONS

AOI	Area of Interest
BLM	Bureau of Land Management
E	East
EPA	United States Environmental Protection Agency
H₂S	hydrogen sulfide
N	North
NCG	Non-condensable gas
NDEP	Nevada Division of Environmental Protection
NDOM	Nevada Division of Minerals
NORM	Naturally Occurring Radioactive Materials
Ormat	ORNI 26 LLC
Project	Gerlach Geothermal Exploration Project
R	Range
T	Township
UTM	Universal Transverse Mercator
WCHD-AQMD	Washoe County Health District–Air Quality Management

1.0 INTRODUCTION AND ORGANIZATION

1.1 Project Summary

ORNI 26 LLC (Ormat) is proposing to construct, operate, and maintain the Gerlach Geothermal Exploration Project (Project) in Washoe County, Nevada, located less than one mile northwest of Gerlach, Nevada (**Figure 1**). The Project would include the drilling and testing of geothermal wells and access road construction.

The wells proposed as part of the Project would be located within federal geothermal leases on public lands managed by the Bureau of Land Management (BLM) (**Figure 1, Table 1**). The Area of Interest (AOI) for the Project encompasses approximately 2,724 acres (**Figure 2**).

Table 1: Federal Geothermal Leases

Lease Number	Township (T) and Range (R)	Section Number	Acreage
NVN55718*	T.32N., R.23E.	All or portions of Sections 9, 10, 15, 16	1,252
NVN75228*	T.32N., R.23E.	All or portions of Sections 3, 4, 10	1,521
NVN98640	T.33N., R.23E.	All or portions of Sections 25, 31, 32, 33, 34, 35, 36	1,040
NVN98641	T.32N., R.23E.	All or portions of Sections 13, 14, 16, 17, 18, 19, 20, 21	1,640
NVN100029	T.32N., R.23E.	All or portions of Sections 15, 16	251

*Gerlach Geothermal Unit Area (NVN88151X) includes leases NVN55718 and NVN75228.

1.2 Summary of Surface Disturbance

Total surface disturbance for the Project would be approximately 49.3 acres (**Table 2**).

Table 2: Maximum Project Surface Disturbance

Activity	Maximum Surface Disturbance (acres)	Maximum Surface Disturbance After Interim Reclamation (acres)
Well Pads	39.9	19.95*
New Road Construction	2.0	2.0
Existing Road Improvement	2.4	2.4
Expanded Existing Aggregate Pit	5.0	5.0
Total	49.3	9.4

* Assumes approximately half of the well pad would remain after interim reclamation.

1.3 Operations Plan Organization

The information contained in this Operations Plan is provided as requested in 43 Code of Federal Regulations 3261.12:

- Well pad layout and design;
- A description of existing and planned access;

- A description of any ancillary facilities;
- The source of drill pad and road building material;
- The water source;
- A statement describing surface ownership;
- Plans for surface reclamation;
- A description of procedures to protect the environment and other resources; and
- Additional information.

Baseline studies completed in support of the Project include cultural resources, biological resources, hydrologic resources (including surface and groundwater), visual resources, and night skies.

2.0 PROJECT DESCRIPTION

2.1 Geothermal Well Field

2.1.1 Well Field Location

Ormat expects that up to 19 geothermal exploration wells would be drilled and tested within the federal geothermal leases (**Figures 3 and 4; Table 3**). Prior to the initiation of exploration drilling activities, Ormat would submit a BLM Geothermal Drilling Permit (BLM Form 3260-2) and drilling program for the specified geothermal exploration well site location for review by the BLM. Additionally, Ormat would obtain the appropriate approvals from the Nevada Division of Minerals (NDOM). After the BLM and NDOM approvals are received, well pad preparation and drilling activities would occur. Further details of well pad preparation activities are included in Section 2.1.2.

Geothermal exploration wells would typically be drilled and tested one at a time. The subsequent location(s) of the geothermal exploration wells to be drilled would be determined from the geothermal reservoir data collected during the drilling operations of the first well, and so forth. The data collected from each exploration well would be used to inform the reservoir model and determine viability of a commercial geothermal resource.

Table 3: Gerlach Well Sites on Federal Geothermal Leases

Well Name (Kettleman No.)	Lease Number	Legal Description ¹ (Section Number & Aliquot Part)	Approximate UTM Coordinates (NAD83)	
			Easting (m)	Northing (m)
11-21	NVN98641	Section 21, NW ¼ of NW ¼	298121	4502331
15-10	NVN75228	Section 10, NW ¼ of SW ¼	299771	4504612
18B-10	NVN75528	Section 10, Lot 1 (SW ¼ of SW ¼)	299754	4504117
24-10	NVN75228	Section 10, SW ¼ of NW ¼	299887	4504815
37-16	NVN98641	Section 16, SE ¼ of SW ¼	298549	4502691
45-16	NVN100029	Section 16, Lot 3 (NW ¼ of SE ¼)	298971	4502959
58-3	NVN75228	Section 3, SW ¼ of SE ¼	300605	4505690
62-20	NVN98641	Section 20, NW ¼ of NE ¼	297491	4502183
63-3	NVN75228	Section 3, SW ¼ of NE ¼	300920	4506573
66-3	NVN75228	Section 3, NW ¼ of SE ¼	300756	4506121
67-16	NVN100029	Section 16, Lot 6 (SW ¼ of SE ¼)	299157	4502676
68-9	NVN55718	Section 9, SW ¼ of SE ¼	299162	4504057
71-3	NVN75228	Section 3, Lot 1 (NE ¼ of NE ¼)	301116	4506988
75-9	NVN55718	Section 9, NE ¼ of SE ¼	299415	4504689
77-9	NVN55718	Section 9, SE ¼ of SE ¼	299291	4504391
82-16	NVN55718	Section 16, NE ¼ of NE ¼	299502	4503779

Well Name (Kettleman)	Lease Number	Legal Description ¹ (Section Number & Aliquot Part)	Approximate UTM Coordinates (NAD83)	
84-16	NVN55718	Section 16, Lot 1 (NE ¼ of NE ¼)	299576	4503260
86-16	NVN100029	Section 16, Lot 4 (NE ¼ of SE ¼)	299586	4502866
87-9	NVN55718	Section 9, SE ¼ of SE ¼	299607	4504269
¹ All wells are located in T.32N., R.23E., Mount Diablo Baseline and Meridian UTM = Universal Transverse Mercator				

2.1.2 Construction Procedures and Surface Disturbance

Each well pad would be approximately 300 feet by 300 feet (approximately 2.1 acres per pad) (**Figure 5**). Actual dimensions of the well pad would be modified to best match the specific physical and environmental characteristics of the site and to minimize grading (cut and fill). Total surface disturbance associated with new well pad construction would be approximately 39.9 acres (2.1 ac./pad * 19 pads).

Drill pad preparation activities would include clearing, earthwork, drainage, and other improvements necessary for efficient and safe operation and for fire prevention. Wells pads would be constructed by a contractor that would work closely with Ormat’s internal drilling engineering team. Only those drill pads scheduled to be drilled would be cleared. Clearing would include removal of organic material, stumps, brush and slash, which would either be removed and taken to an appropriate dump site or left on-site. Topsoil would be stripped (typically to the rooting depth) and salvaged during the construction of all pads, as feasible. Salvaged topsoil (and cleared organic material, stumps, brush and slash, if saved) would be stockpiled on the pads for use during subsequent reclamation of the disturbed areas.

Each drill pad would be prepared to create a level pad for the drill rig and a graded surface for the support equipment. Storm water runoff from undisturbed areas around the constructed drill pads would be directed into ditches surrounding the drill pad and back onto undisturbed ground, consistent with best management practices for storm water. The pad surface would be graded to prevent the movement of storm water off the constructed site but rather into the reserve pit in accordance with the standards of the “Surface Operating Standards and Guidelines for Oil and Gas Exploration and Development (The Gold Book)” (Fourth Edition – Revised 2007) (BLM and Forest Service 2007).

Reserve pits would also be constructed in accordance with best management practices identified in the “The Gold Book” (Fourth Edition – Revised 2007) (BLM and Forest Service 2007) on each pad for the containment and temporary storage of water, drill cuttings and circulating drilling mud during drilling operations. Geothermal fluid produced from the well during flow testing would also drain to the reserve pit.

The reserve pits would be fenced with an enclosure fence on three sides and then fenced on the fourth side once drilling has been completed (approximately 45 days) to prevent access by persons, wildlife, or livestock (**Figure 6**). The fence would be built according to rangeland management specifications and would remain in place until pit reclamation begins. To prevent livestock, wildlife, and persons from becoming entrapped, one side of the reserve pit walls would

be sloped at an approximate 30 percent incline. The reserve pit would measure approximately 75 feet by 200 feet by 10 feet deep.

Once drilling is complete, the shoulders of the pad could be reclaimed, but the majority of the pad must be kept clear for ongoing operations and the potential need to work on or re-drill the well. See Section 2.5 for a description of reclamation procedures.

2.1.3 Well Drilling and Testing

Specific drilling information is provided in **Table 4**.

Table 4: Well Drilling Specifics

Rig Type	Rig Height (feet)	Trucks Needed (on average)	Drilling Time (days) ¹	Workers On-Site	Depth Drilled (feet)
Large rotary drilling rig	160-170	25+ tractor/trailer 8 small trucks	45 ²	Avg. = 9-10 Max = 18	~ 7,000
¹ Difficulties encountered during the drilling process, including the need to re-drill the well, could as much as double the time required to successfully complete each well. ² Drilling would be conducted 24 hours a day, 7 days a week.					

The drilling supervisor and mud logger would typically sleep in a trailer (temporary ancillary facility) on the active drill site while the well is being drilled. The drilling crew may also live “on-site” during the drilling operations in a self-contained, mobile “bunkhouse” (temporary ancillary facility) (comparable in size to a double-wide trailer, containing sleeping quarters, galley, water tank, and septic tank) or portable trailers. These temporary ancillary facilities for the drilling crew would be placed on one of the drill sites not being actively drilled, or in the case of the first well to be drilled, quarters would be placed on the active well pad. Drilling crews typically include one drilling supervisor, one company man, one mud logger, one tool pusher, one derrickman, one motorman, and up to four floorhands. Alternatively, the drilling crew may acquire accommodations in Gerlach, depending on lodging availability.

“Blow-out” prevention equipment would be utilized while drilling below the surface casing. During drilling operations, a minimum of 10,000 gallons of cool water and 12,000 pounds of inert, non-toxic, non-hazardous barite (barium sulfate) would be stored at each well site for use in preventing uncontrolled well flow (i.e., “killing the well”), as necessary.

The well bore would be drilled using non-toxic, temperature-stable drilling mud composed of a bentonite clay-water or polymer-water mix for all wells. Variable concentrations of additives would be added to the drilling mud as needed to prevent corrosion, increase mud weight, and prevent mud loss. Some of the mud additives may be hazardous substances, but they would only be used in low concentrations that would not render the drilling mud toxic. Additional drilling mud would be mixed and added to the mud system as needed to maintain the required quantities.

Target depths at the Gerlach geothermal field range between 1,500 and 7,500 feet below ground surface but may change pending results of well testing. Further, depending on the subsurface targets, directional drilling may be employed to intercept geothermal targets. Well casing would meet all requirements outlined in Geothermal Resources Operational Order No. 2, where the

surface casing string would be set at no less than 200 feet to prevent co-mingling of the geothermal fluids with underground aquifers.

Each well may need to be worked over or redrilled. Well redrilling may consist of: 1) reentering and redrilling the existing well bore; 2) reentering the existing well bore and drilling and casing a new well bore; or 3) sliding the rig over a few feet on the same well pad and drilling a new well bore through a new conductor casing. While the drill rig is still over the well, the residual drilling mud and cuttings would be flowed from the well bore and discharged to the reserve pit.

Short-Term Well Testing

Each short-term well test, lasting approximately three to five days on average, would consist of flowing the well into the reserve pit or portable steel tanks brought onto the well site while monitoring geothermal fluid temperatures, pressures, flow rates, chemistry, and other parameters. An “injectivity” test may also be conducted by injecting the produced geothermal fluid from the reserve pit or steel tanks back into the well and the geothermal reservoir. The drill rig would likely be moved from the well site following completion of the short-term test(s). Each short-term well test is expected to flow approximately 1.5 million gallons of geothermal brine.

Long-Term Well Testing

One or more long-term flow test(s) of each well drilled would likely be conducted following the short-term flow test(s), to more accurately determine long-term well and geothermal reservoir productivity. The long-term flow test(s), each lasting between seven and 30 days, would be conducted by pumping the geothermal fluids from the well through on-site test equipment, closed to the atmosphere (using a line shaft turbine pump or electric submersible pump), to the reserve pit. A surface booster pump would then pump the residual produced geothermal water/fluid through a temporary eight to ten-inch diameter pipeline to either inject the fluid into one of the other geothermal wells drilled within the Project area or to the reserve pit on another well pad.

The temporary pipeline would be carried by workers and hand laid either “cross-country” or on the surface of the disturbed shoulders on the access roads connecting the full-size geothermal wells (as required, roads would be crossed by trenching and burying the temporary pipe in the trench). The temporary pipeline typically consists of aluminum or high-density polyethylene (HDPE) piping appropriately rated for the temperatures and pressures for the long-term flow test(s). Temporary pipeline connections are bolted or welded together and Ormat personnel and/or contractor(s) would be on-site monitoring the temporary pipeline and wells during the long-term flow test(s). The on-site test equipment would include standard flow metering, recording, and sampling apparatus. Each long-term well test is expected to flow approximately 15 million gallons of geothermal brine.

2.2 Site Access and Road Construction

Principal access to the Project area is from NV-447 and County Road 34. The Project area is traversed by numerous roads and “two-tracks.” All existing access roads would require an

additional 10 feet width of surface disturbance for road improvement. Well sites requiring new access roads would require a total of 20 feet width of surface disturbance in order to accommodate a 15-foot-wide drivable roadbed. New and improved access roads would be constructed using a dozer and/or road grader. New and/or improved access roads would be required as identified in **Table 5 (Figures 3 and 4)**:

Table 5: Road Construction Lengths and Disturbance Totals

Access Road Type	Road Length (feet)	Road Length (miles)	Disturbance (acre)
New Road	4,398	0.8	2.0
Improved Road	10,602	2.0	2.4
Total	15,000	2.8	4.4

The total estimated area of surface disturbance required for new access road construction, assuming a 15-foot wide drivable roadbed (20-foot wide total width of surface disturbance) would be approximately 2.0 acres (4,398 feet of road * 20-foot-wide surface). Total estimated area of surface disturbance required for improvements to existing access roads would be approximately 2.4 acres (10,602 feet of existing road * 10-foot-wide additional surface disturbance). In sum, it is estimated that a total of 4.4 acres of disturbance would be required for access road construction within the Project AOI.

Constructed access roads crossing existing drainages may require installation of culverts. Culvert installation would follow BLM design criteria and would be constructed pursuant to standards established in the Gold Book (Fourth Edition - Revised 2007). If required, Ormat would obtain all appropriate permits for site access with the Nevada Department of Transportation, prior to exploration activities.

2.3 Water Requirements and Source

Water required for well drilling could range up to as much as 35,000 gallons per day. Water requirements for grading, construction, and dust control would average substantially less, at around 6,000 gallons per day. One or more portable water tank(s), holding a combined total of at least 10,000 gallons, would be maintained on the well sites during drilling operations.

Water necessary for these activities would be obtained from shallow water well(s) drilled from one or more of the proposed drill sites, as approved by the BLM and under a waiver for the temporary use of ground water from the Nevada Department of Water Resources (Nevada Administrative Code [NAC] 534.444), where each well location would be determined upon individual need, likely at a pad central to the Project area. Each water well would be temporary, drilled by a licensed water well driller and cemented with seven-inch casing to provide a sanitary seal at the surface. The well would be drilled down to a productive interval of sands, gravels, or fractures (estimated at between 100 and 1,000 feet below ground surface). An electric submersible pump on four-inch column pipe would then be run to below the producing interval. The well would be plugged and abandoned in accordance with NAC 534.420, with cement plugs across the bottom of the casing and, if needed, with additional plugs to isolate individual producing zones if identified as present. No additional surface disturbance would be associated

with the drilling of each temporary water well because, if drilled, they would be located on existing geothermal well pads.

Alternatively, water could be obtained from an established private ranch source and trucked to each construction or drill site, or as a bulk water purchase from the Gerlach General Improvement District (GGID), pending contract and availability from the GGID.

2.4 Aggregate Requirements and Source

Aggregate material would be obtained from a private aggregate pit located east of Transfer Station Road (**Figures 3 and 4, Table 6**), or another local source, if found. If the private aggregate pit is used for the Project, the existing pit would be expanded by up to five acres.

Table 6: Existing Aggregate Sources

Aggregate Source Area	Township, Range, Section	Approximate UTM Coordinates (NAD83)	
		Easting (m)	Northing (m)
Aggregate Pit (Existing Private Source)	T.32N., R.23E., Sec. 15	299851	4503528

Drill pads and access roads were selected to minimize the need for aggregate application, with the majority of the proposed well pads consisting of an approximate even mix of cut and fill to make a stable surface. At most, each drill pad (exclusive of the reserve pit) would be covered with up to six inches of gravel. While the Project would likely utilize much less, a conservative estimate for the total aggregate required for well pad construction is estimated at 38,000 cubic yards (approximately 2,000 cubic yards/pad * 19 pads).

Access roads would be covered with up to four inches of gravel, as necessary to create an all-weather surface and to prevent the formation of ruts. Total aggregate required for access road construction is estimated at 2,778 cubic yards (approximately 32.8 miles of access roads * 15-foot width * 4-inch depth).

Total aggregate required for the well pad and access road construction is estimated at 40,778 cubic yards.

2.5 Personnel

A temporary drilling crew of approximately 10 workers would be at the active drill site for the entire duration of well drilling (approximately 45 days). The drilling crew is anticipated to consist of current Ormat employees and contractor(s) that would travel to the Project site for exploration activities, as needed.

2.6 Surface Reclamation

After the well drilling and testing operations are completed, the liquids from the reserve pits would either naturally evaporate or be removed as necessary to reclaim the reserve pits. The solid contents remaining in each of the reserve pits, typically consisting of non-hazardous, non-toxic drilling mud and rock cuttings, would be tested to confirm that they are not hazardous. Typical tests may include the Toxicity Characteristic Leaching Procedure (United States Environmental Protection Agency [EPA] Method 1311), tested for heavy metals; pH (EPA method 9045D); Total Petroleum Hydrocarbons/Diesel (EPA Method 8015B); and Oil and Grease (EPA Method 413.1). Non-hazardous and non-toxic drilling mud and cuttings would be buried in the reserve pit, and any drilling mud and/or cuttings identified as hazardous and toxic would be disposed of according to Nevada Division of Environmental Protection (NDEP) regulations.

If a well is judged by Ormat to have no commercial potential, it may continue to be monitored for the Project, but would be plugged and abandoned in conformance with the well abandonment requirements of the BLM and Nevada Division of Minerals (NDOM). Abandonment typically involves filling the well bore with clean, heavy abandonment mud and cement until the top of the cement is at ground level, which is designed to ensure that fluids would not move across these barriers into different aquifers. The well head (and any other equipment) would then be removed, the casing cut off well below ground surface, and the hole backfilled to the surface.

The portions of the cleared well sites not needed for operational and safety purposes (i.e., the “shoulders” of the pad) would be recontoured to a final or intermediate contour that would blend with the surrounding topography as much as possible. Areas able to be reclaimed would be ripped, tilled, or disked on contour, as necessary and reseeded with native grasses and forbs. The stockpiled topsoil would also be spread on the area to aid in revegetation. Road reclamation would involve recontouring the roads back to the original contour and seeding with a BLM-approved seed mix.

3.0 ENVIRONMENTAL PROTECTION

3.1 Adopted Environmental Protection Measures

Ormat would comply with all special lease stipulations attached to leases NVN55718, NVN75228, NVN98640, NVN98641, and NVN100029, which are applicable to Project operations. In addition to measures described in the following sections, Ormat would also institute the following measures:

- Water would be applied to the ground during the construction and utilization of the drill pads, access roads, and other disturbed areas as necessary to control dust.
- Portable chemical sanitary facilities would be available and used by all personnel during periods of well drilling and/or flow testing, and construction. These facilities would be maintained by a local contractor.
- To prevent the spread of invasive, nonnative species, all vehicles, heavy earth-moving construction equipment, mobile trailers and RV campers brought to and used on the Project site would go through high pressure washing of the entire vehicle/unit at a commercial wash station prior to arriving and/or being used on the Project site.
- If needed, certified noxious weed free hay and straw bales would be purchased and used on the Project site.
- Seed mixes for the rehabilitation and/or re-vegetation of all disturbed areas related to this Project would be certified as weed-free, per BLM standards.
- All construction and operating equipment would be equipped with applicable exhaust spark arresters. Fire extinguishers would be available on the active sites. Water that is used for construction and dust control would be available for firefighting. Personnel would be allowed to smoke only in designated areas.
- Following Project construction, areas of disturbed land no longer required for operations would be reclaimed to promote the reestablishment of native plant and wildlife habitat.
- Any areas containing eligible and unevaluated cultural sites would be avoided, or the potential for impacts mitigated in a manner acceptable to the BLM. Ormat employees, contractors, and suppliers would be reminded that all cultural resources are protected and if uncovered shall be left in place and reported to the Ormat representative and/or their supervisor.
- The wellheads would each be painted a color that blends with the surrounding landscape to minimize visibility.

3.2 Fire Prevention and Control

Fire Contingency Plan

1. Small fires may occur around the well pad during drilling and/or testing operations. These fires would be controlled by rig personnel utilizing on-site firefighting equipment.

2. The BLM Winnemucca District Office (775.623.1500) would be notified of any wildland fire, even if the available personnel can handle the situation or the fire poses no threat to the surrounding area. Additionally, the Sierra Front Interagency Dispatch would be notified (775.883.5995).
3. A roster of emergency phone numbers would be available on-site so that the appropriate firefighting agency can be contacted in case of a fire.
4. All vehicles shall carry at a minimum a shovel and five gallons of water (preferably in a backpack pump), in addition to a conventional fire extinguisher.
5. Adequate firefighting equipment (a shovel, a Pulaski, standard fire extinguisher(s), and at least a 100-gallon water tank with pump) shall be kept readily available at each active drill site.
6. Vehicle catalytic converters (on vehicles that would enter and leave the drill site on a regular basis) shall be inspected often and cleaned of all flammable debris.
7. All cutting/welding torch use, electric-arc welding, and grinding operations shall be conducted in an area free, or mostly free, from vegetation. At least a 100-gallon water tank with pump and shovel shall be on hand to extinguish any fires created from sparks. A welding tent would be used, as appropriate. At least one person in addition to the cutter/welder/grinder shall be at the work site to promptly detect fires created by sparks. Ormat would comply with all OSHA requirements for metal work, as applicable to the Project.
8. Personnel would be responsible for being aware of and complying with the requirements of any fire restrictions or closures issued by the BLM Winnemucca District Office, as publicized in the local media or posted at various sites throughout the field office district.

3.3 Surface and Ground Water Protection

Exclusive of short- and long-term flow testing wherein fluids would be discharged to the reserve pit, geothermal fluids would not be discharged to the ground under normal operating conditions. Also, each drill pad is graded towards the reserve pit to prevent movement of storm water runoff from the pad. Further, geothermal wells are cased to prevent co-mingling of the geothermal fluids with underground aquifers.

Each drill pad would be prepared to create a level pad for the drill rig and a graded surface for the support equipment. Storm water runoff from undisturbed areas around the constructed drill pads would be directed into ditches surrounding the drill pad and back onto undisturbed ground, consistent with best management practices for storm water. The site would be graded to prevent the movement of storm water from the pad off the constructed site to areas of natural drainage in conformance with “The Gold Book” standards (BLM and Forest Service 2007). A stormwater pollution prevention plan would be developed and implemented for the Project per the NDEP Bureau of Water Pollution Control requirements.

3.4 Wildlife Protection

Erosion control/soils protection measures after construction would include revegetation and periodic maintenance. Disturbed areas that would not be used after construction would be revegetated with the proper seed mixture and planting procedures prescribed by the BLM. Topsoil may be stockpiled on previously disturbed areas and applied to enhance areas to be reclaimed by revegetation.

To prevent undue degradation and removal of habitat, cover and food, existing roads would be used whenever possible and cross-country travel would be restricted to designated construction areas. Speed limits of 35 miles per hour would be observed on all unpaved roads in the Project area in order to minimize dust and avoid collision and incidental death of local wildlife.

To prevent a potential violation of the Migratory Bird Treaty Act and per lease stipulations, Ormat would contract a qualified wildlife biologist to conduct a preconstruction survey for nesting migratory birds during the breeding season (March 1 – August 31) and prior to any ground clearing or other surface disturbance. The survey would include the proposed footprint of disturbance and an appropriate-sized buffer area. If disturbance is not completed within the timeframe established as a condition in the Geothermal Drilling Permit for the preconstruction survey, an additional survey may be required after consultation with the BLM. If active nests are found, and in consultation with the BLM, an appropriately sized buffer would be established to exclude any disturbance around the nest until the nesting attempt has been completed. If active nests are not found, surface disturbance activities would occur within the survey validity timeframe.

3.5 Cultural Resource Protection

Cultural resource surveys have been conducted. In consultation with BLM and with Nevada State Historic Preservation Office concurrence, any areas which contain cultural resources of significance or whose eligibility for inclusion on the National Register of Historic Places is unevaluated, would be mitigated or “treated” and recorded as appropriate. Ormat employees, contractors, and suppliers would be reminded that all cultural resources are protected and if uncovered, the resource shall be left in place, work would cease, and notification would be made to the Ormat representative and the appropriate BLM authorized officer, by telephone, with written confirmation to follow, immediately upon such discovery.

3.6 Minimization of Air Pollution

Ormat would comply with any air quality requirements prescribed by the Washoe County Health District–Air Quality Management Division (WCHD-AQMD). Water would be applied to the ground during the construction and utilization of the drill pads and access roads, as necessary to control fugitive dust.

Ormat would obtain a Dust Control Permit with the WCHD-AQMD and implement the required actions to minimize fugitive dust emissions during the well drilling and construction phases of the Project.

3.7 Minimization of Noise Pollution

To abate noise pollution, mufflers would be used on all drilling rig engines. Each well pad may have one rock muffler. Rock mufflers are approximately 30 feet tall with a diameter of about 10 feet and are used to attenuate steam venting noise during well testing.

3.8 Minimization of Hazards to Public Health and Safety

Construction and operation activities would be conducted in a manner to avoid creating any hazards to public health and safety. Injury contingency, spill or discharge contingency, and hydrogen sulfide (H₂S) contingency plans are provided below:

Injury Contingency Plan

Drilling operators are required by law to safety train workers and to have first aid equipment on-site. Ormat supervises the drilling operations to ensure that all safety procedures and best safety practices are in place and adhered to throughout the drilling program. Ormat's drilling operations are required to be in compliance with all existing laws pertaining to safety and environmental protection. Safety meetings are held prior to any major operation, such as running casing, cementing, or unloading the well. Drilling contractors would typically have daily safety meeting with crews and review any issues that could come up during the 12 hours that each crew is at work.

In the event injuries occur in connection with an Ormat operation, specific and immediate attention would be given, along with proper transportation to a medical facility.

- Ambulance (911)
- Saint Mary's Regional Medical Center
235 W 6th Street
Reno, NV 89503

Spill or Discharge Contingency Plan

1) Potential Sources of Accidental Spills or Discharges

a) Geothermal Fluid

- i) In the event of an accidental geothermal fluid spill or discharges, blowout prevention equipment would be utilized to shut down the flow from the wellhead. To protect groundwater resources, it is an industry standard practice to case geothermal wells in the subsurface to prevent co-mingling of the geothermal fluids with groundwater aquifers. Depth of the casings are determined by the hydrogeology of the area. An accidental discharges or spills could result from any of the following:
 - (1) Loss of well control (blowout);
 - (2) Pipeline leak or rupture; or
 - (3) Leakage from test tank.

b) Drilling Muds

i) Muds are a mixture of water, non-toxic chemicals and solid particles used in the drilling operations to lubricate and cool the bit in the hole, to carry cuttings out of the hole, to maintain the hole condition and to control formation pressure. Drilling muds are prepared and stored in metal tanks at the drilling site. Waste drilling mud and cuttings are discharged into the reserve pit, which is open and is adequately sized to hold the volume necessary for the operation. Accidental discharges of drilling mud could occur by:

- (1) Overflow of the reserve pit;
- (2) Reserve pit wall seepage or wall failure;
- (3) Discharge from equipment failure on location; or
- (4) Shallow lost circulation channeling to the surface.

c) Lubricating or Fuel Oils and Petroleum Products

i) To minimize the potential for spills, all petroleum products on-site are labeled, stored, and handled in conformance with applicable federal and state requirements. All materials except diesel fuel are stored in the original shipping containers. Diesel fuel is stored in on-board tanks on the drill rig and replenished from a bulk tank truck using an electric transfer pump and hard lines with secondary containment used during drilling operations in case of accidental spills. Supervisors trained in spill prevention, containment and clean-up are on-site, 24 hours a day. Potential locations for accidental spills are:

- (1) Drilling equipment and machinery at and around the drilling location;
- (2) Other miscellaneous equipment and machinery at well site and roads;
- (3) Storage areas; and
- (4) Equipment servicing areas.

d) Construction/Maintenance Debris

i) Trash shall be contained on-site and hauled to an approved landfill. Burial of trash on-site shall not be permitted.

e) Plan for Cleanup and Abatement

i) In the event of discharge of formation fluids, drilling muds or petroleum products, the person responsible for the operation would make an immediate investigation, then contact the Drilling Supervisor and advise of the spill. The Drilling Supervisor would in turn call out equipment, regulate field operations, or do other work as applicable for control and cleanup of the spill, as follows:

(1) Action - Small, Containable Spill

If the spill is small (i.e., less than 25 gallons) and easily containable without endangering the watershed, the Drilling Supervisor would direct and supervise complete cleanup and return to normal operations.

(2) Action - Large or Uncontainable Spill

If the spill is larger than 25 gallons, or is not easily contained, endangers, or has entered the watershed, the Drilling Supervisor would proceed to take necessary

action to curtail, contain and clean up the spill, as above, and notify personnel as listed below.

(3) Notification

The Drilling Supervisor would, as quickly as practicable:

- (a) Call out contractor(s), as required.
- (b) Notify the Ormat Project Manager.
- (c) Notify the local and state law enforcement agencies if the public safety is threatened.
- (d) The Ormat Project Manager would notify the following as soon as practical and work closely with them in all phases of the curtailment, containment, and cleanup operations:

NDOM	NDEP
State of Nevada	Division of Emergency Management
400 W. King	2525 Carson St.
Carson City, NV 89703	Carson City, NV 89711
775.684.7040	775.687.4240

BLM Winnemucca District Office
(within 24 hours of the knowledge of a reportable release)
5100 E. Winnemucca Blvd.
Winnemucca, NV 89445
775.623.1500

National Response Center
800.424.8802

The Drilling Supervisor would also advise local population and affected property owners, if spill affects residents or property.

f) Specific Procedures

- (1) For geothermal fluid spills:
Contain spillage with dikes if possible and haul to disposal site by vacuum or water trucks or dispose of in a manner acceptable to the NDOM and BLM.
- (2) For drilling mud:
Repair reserve pit or contain with dikes. Haul liquid to another reserve pit, available tanks, or approved disposal site.
- (3) For petroleum products:
Contain spill with available manpower. Use absorbents and dispose of same in approved disposal area. Spills of petroleum products in excess of 25 gallons must be reported to NDEP as soon as possible, but no later than the end of the first working day of the release at:
 - In-state: 775.687.9485
 - Out-of-state: 888.331.6337

For (1) through (3) above, Ormat would have the source of spill repaired at the earliest practical time and continue working crews and equipment on cleanup until all concerned agencies are satisfied.

- g) Confirm notification to agencies and regulatory bodies.
Telephone notification shall be confirmed by the Ormat Project Manager in writing, within two weeks of telephone notification. Written confirmation would contain:
- (1) Reason for the discharge or spillage.
 - (2) Duration and volume of discharge or spillage.
 - (3) Steps taken to correct problem.
 - (4) Steps taken to prevent recurrence of problem.

Hydrogen Sulfide Contingency Plan

Non-condensable gas (NCG) concentrations within geothermal systems can vary greatly and depend on the temperature, geologic setting, and rock types. The Project is considered a non-magmatic, low-enthalpy type geothermal system so it is reasonable to assume H₂S concentrations are low and do not need abatement. During exploration drilling, well control practices keep the geothermal fluids in the reservoir so there is no exposure pathway. During flow tests, brine is directed to a flash vessel which directs steam and exsolved NCGs, such as H₂S, upwards and well above head level. Additionally, the steps below would be taken to help prevent exposure to H₂S during exploration drilling and testing:

1. Although there is very little chance that drilling in these moderate-temperature geothermal reservoirs would encounter substantial H₂S, continuous H₂S monitors would be on the rig floor and at the mud tanks and shaker to alert workers should elevated H₂S levels be detected. Personal H₂S monitors would be required for all onsite drilling personnel. Signs would be posted to inform workers and visitors of any potential issues.
2. Drilling parameters would be continuously monitored, and any changes in gas concentrations, formation pressures, or potential for flow are provided to the driller and supervisor. The blowout prevention equipment would be in place to shut off any unexpected gas flows. In the event any evidence of high gas concentrations are detected in the drilling fluids, the drilling fluids consultant would obtain materials and design a program to safely circulate out the gas bubble and to treat and remove any H₂S using caustic soda, peroxide, soda ash, lime, or other technology as appropriate.

Naturally Occurring Radioactive Materials (NORM)

There is no known source of elevated NORM at the Project, such as young marine shales or potassium-rich granitic bodies. The main rock units in the Project area include alluvium (minor sediments such as sandstone and siltstone) and granite. Additionally, exposure to NORM through geothermal scale should not be a consideration since there would be no long-term production through piping during this exploration phase of the Project.

4.0 REFERENCES

BLM and Forest Service (U.S. Department of the Interior, Bureau of Land Management and U.S. Department of Agriculture, Forest Service). 2007. Surface Operating Standards and Guidelines for Oil and Gas Exploration and Development, “The Gold Book” (fourth edition). BLM/WO/ST-06/021+3071/REV07. Denver, Colorado.

Spidell, Jason, Kristina Wiggins, and Scott Campbell. 2021. Cultural Resources Inventory for the Ormat Nevada, Inc. Gerlach Geothermal Development Project, Washoe County, Nevada. BLM Report CR2-3489. Kautz Environmental Consultants, Inc., Reno, Nevada.

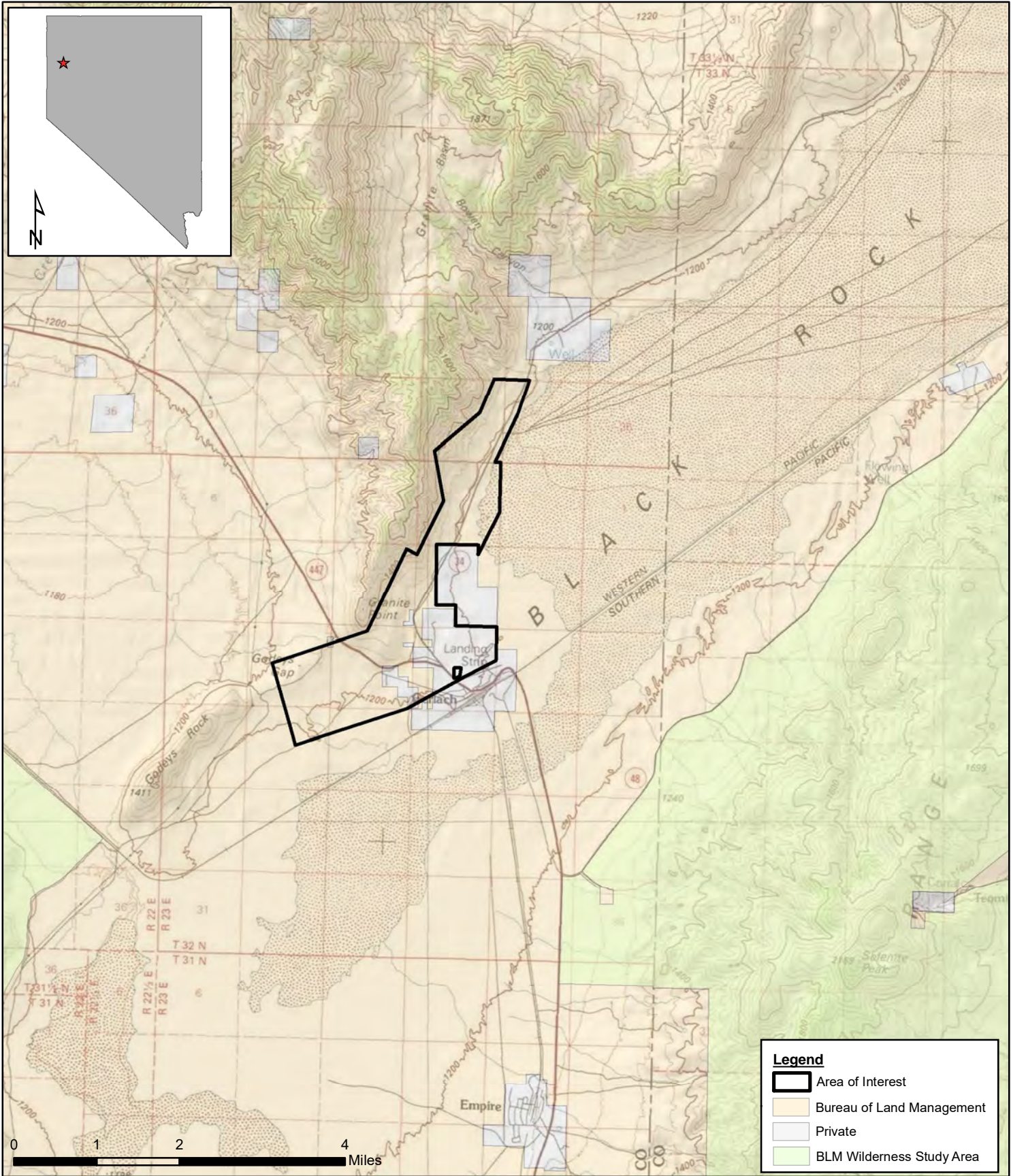

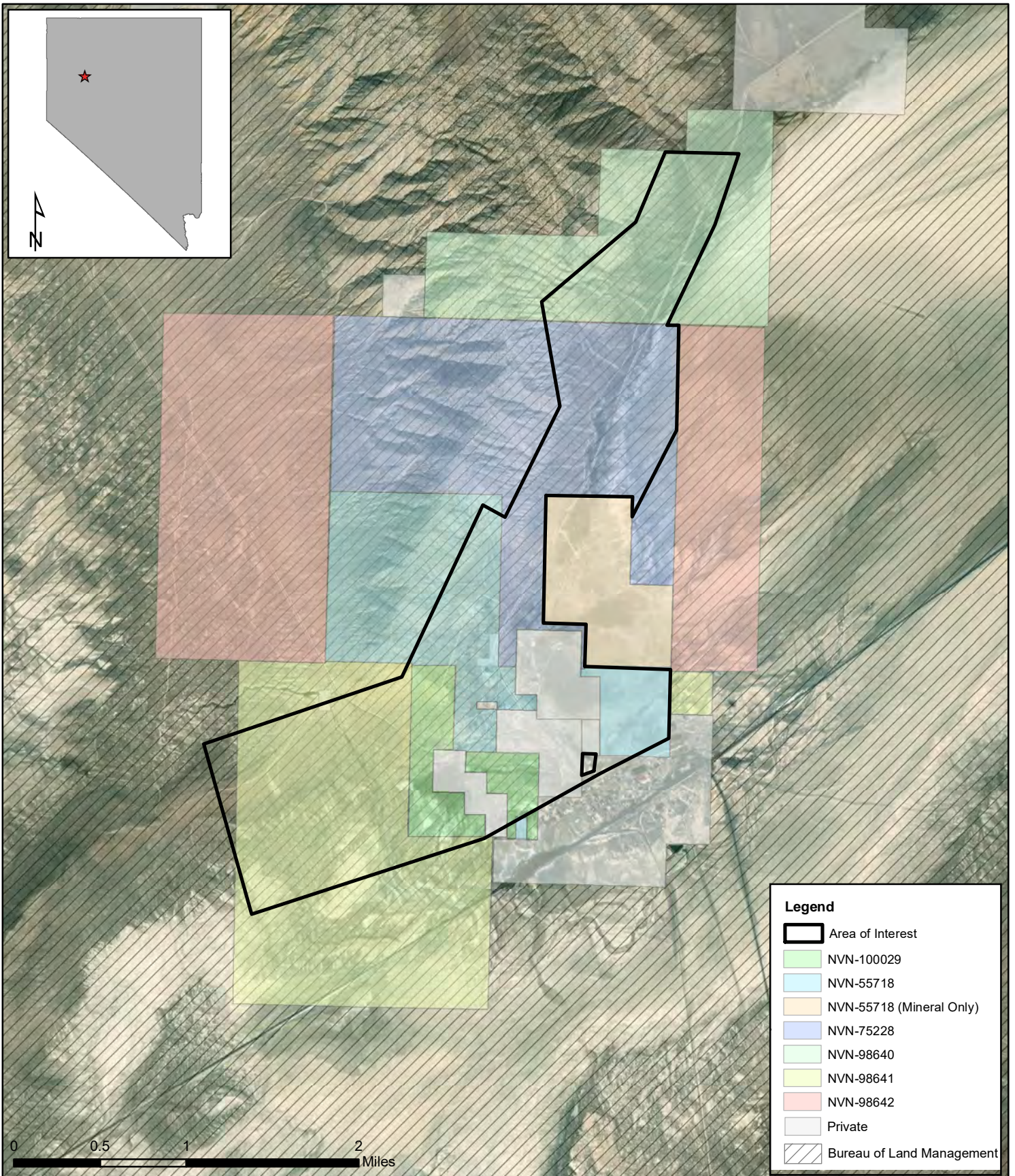

Gerlach Geothermal Exploration Project
 Washoe County, Nevada, USA

Figure 2: Federal Geothermal Lease Map

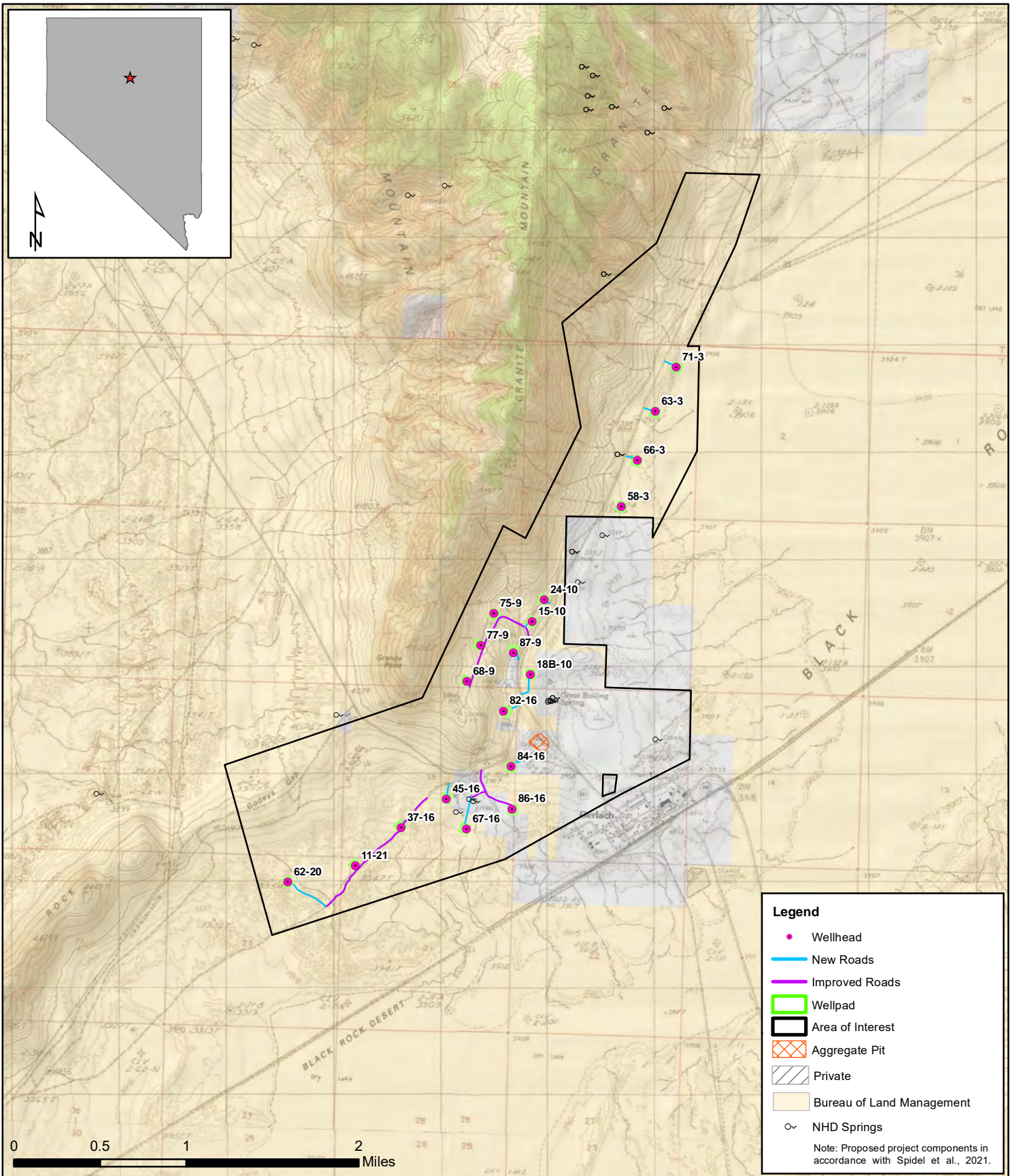

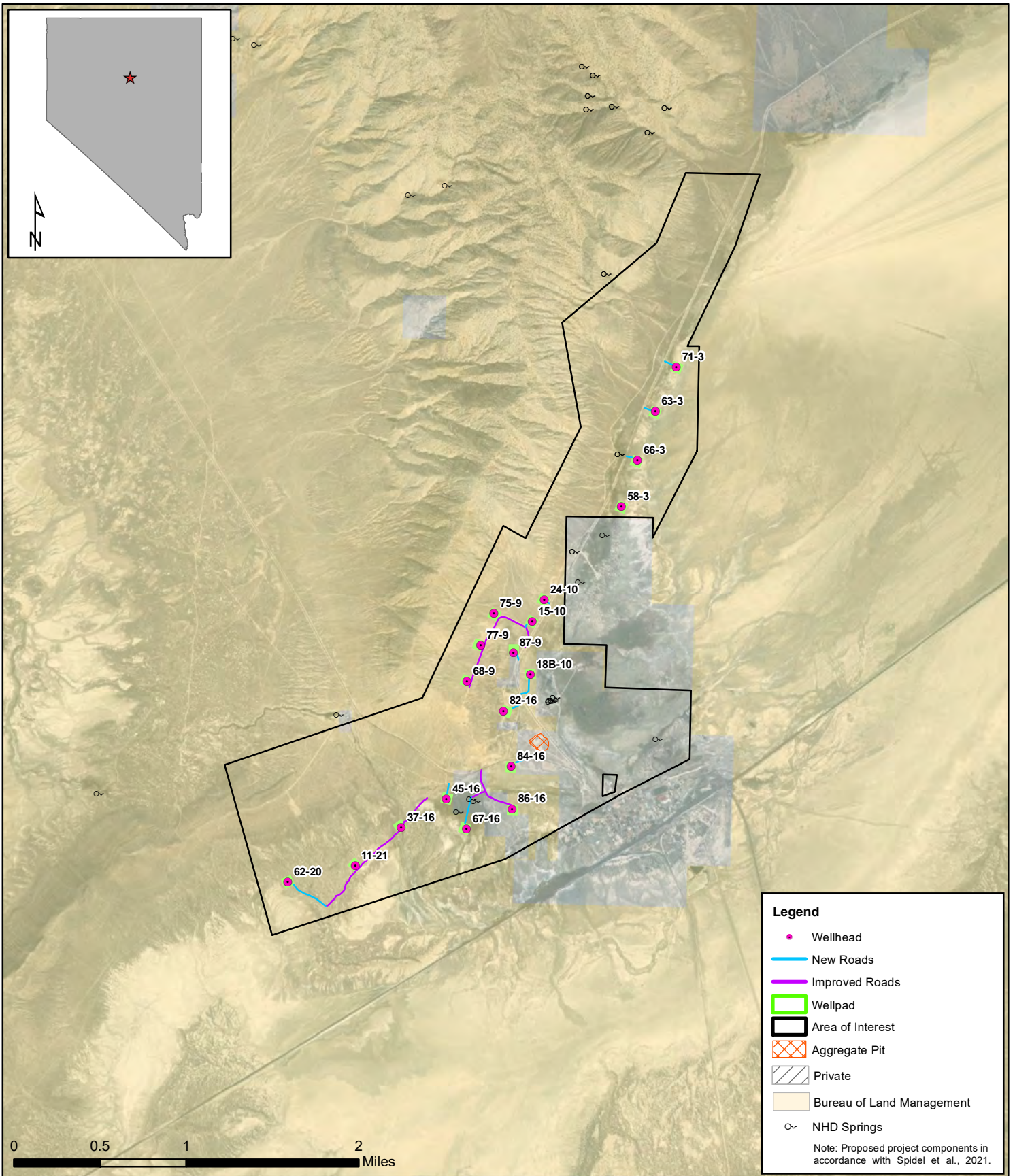

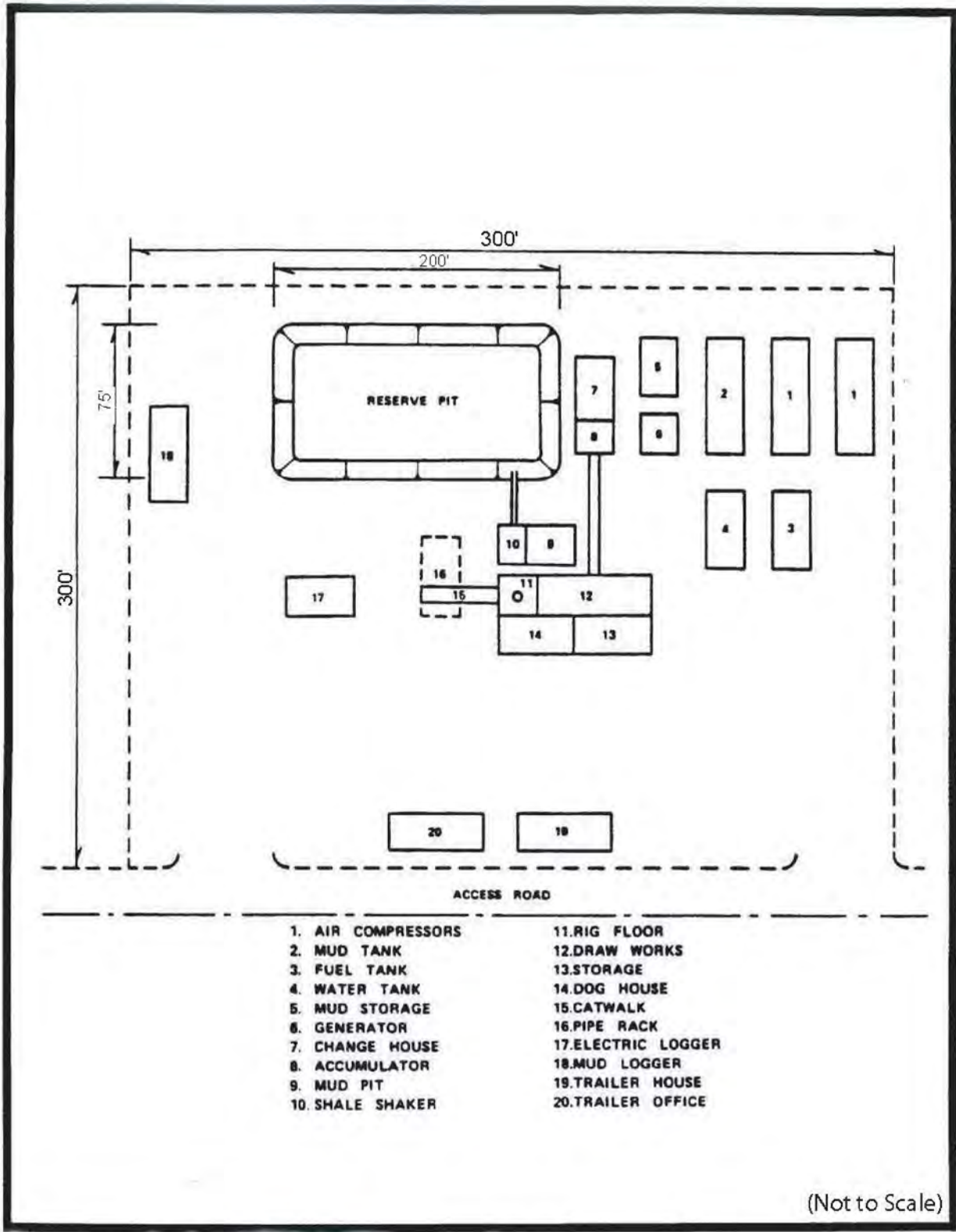

Gerlach Geothermal Exploration Project

Washoe County, Nevada, USA

Figure 5: Well Pad Layout and Design

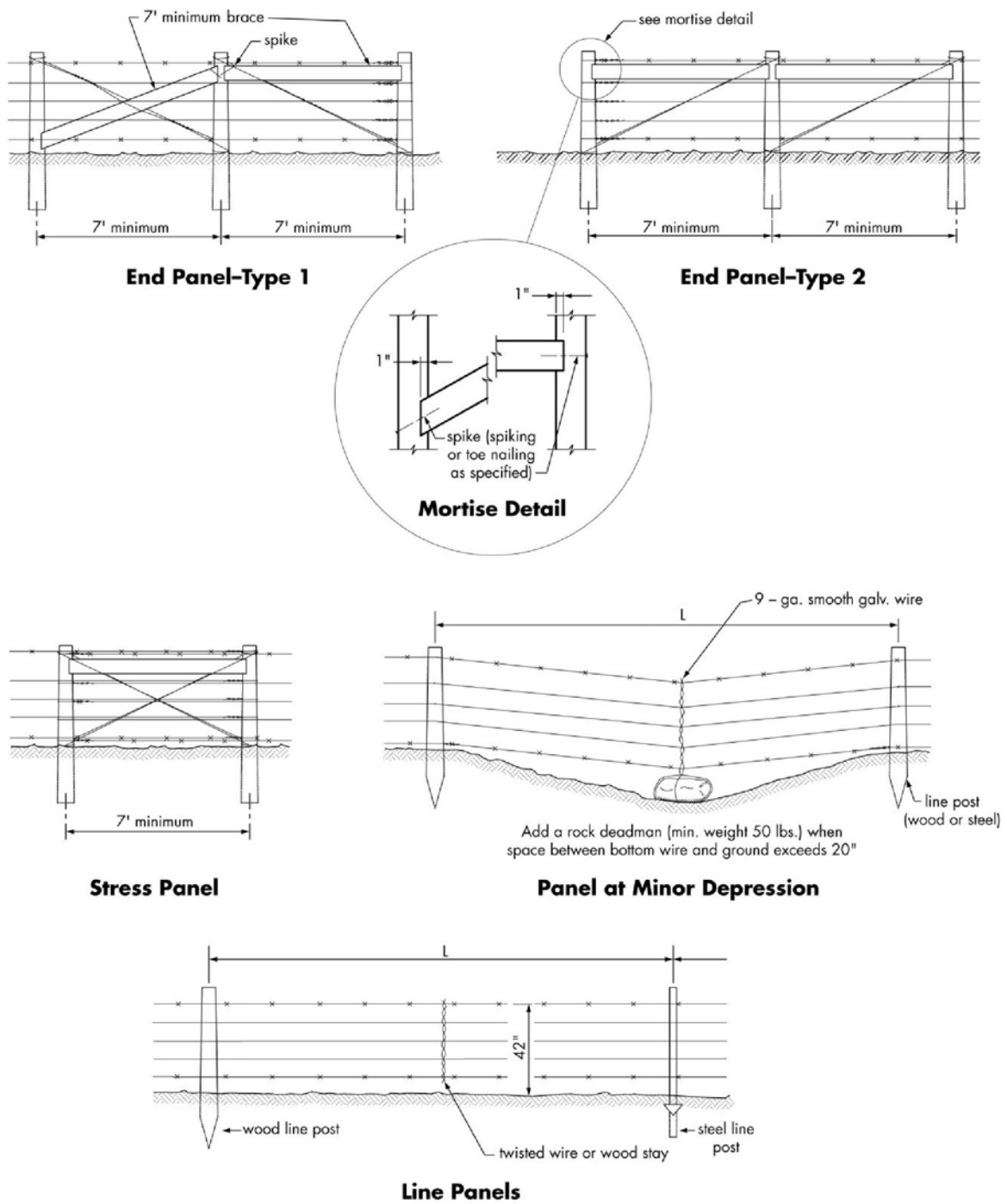

Not to Scale



Gerlach Geothermal Exploration Project

Washoe County, Nevada, USA

Figure 6: Recommended Construction Standards for Enclosure Fences in Livestock Areas